

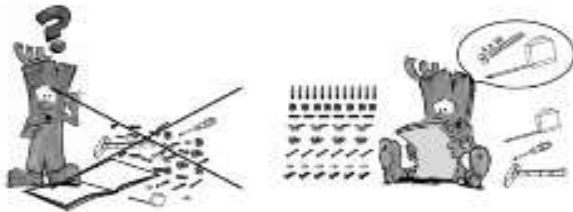

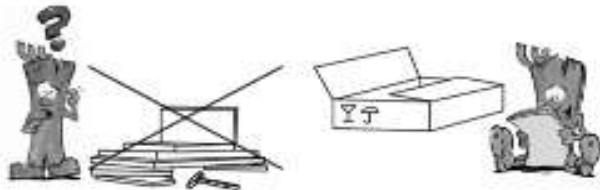





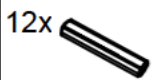
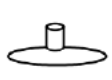

2 ΧΡΟΝΙΑ ΕΓΓΥΗΣΗ



A	932x270	1/1
B	932x270	1/1
C	800x270	1/1
D	2x 768x267	1/1
E	768x267	1/1
F	768x80	1/1
G	3x 858x263	1/1

10x  10174	12x  10013	10x  50317	8x  50332
4x  50709	34x  10033	1x  10060 6x50	1x  10009 4x50
1x  50421 30x30	2x  10001 3,5x16		

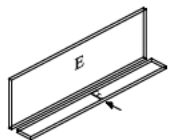
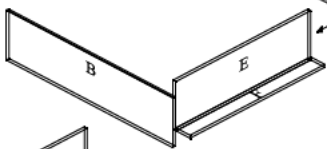
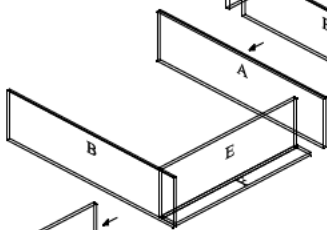
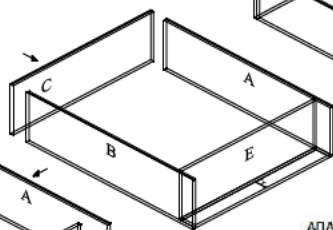
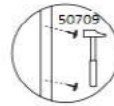
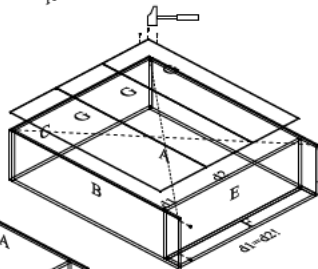
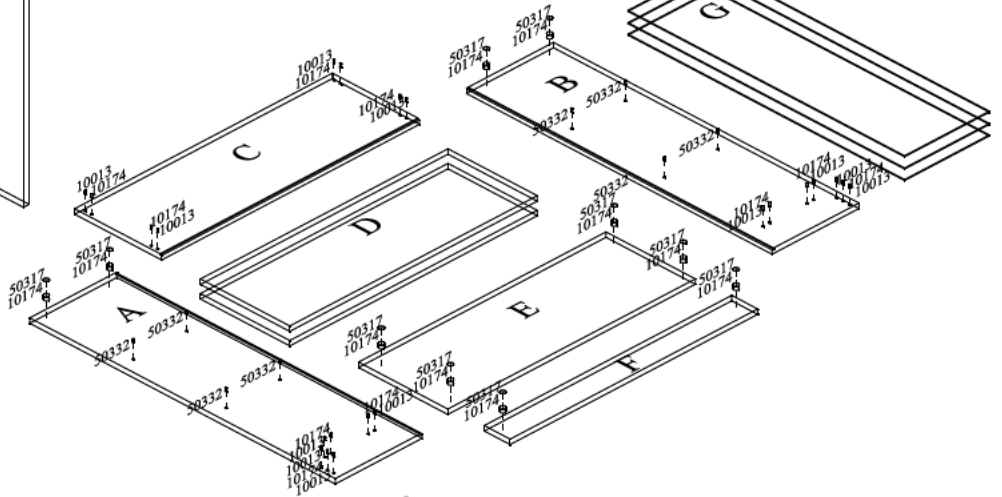
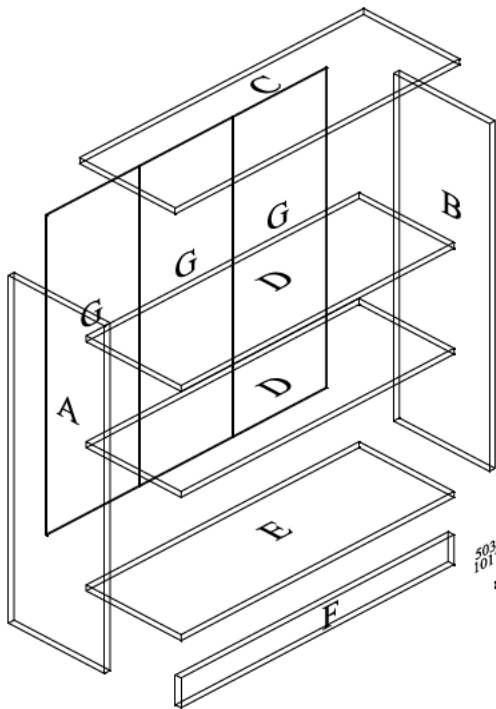

ΑΠΑΡΑΙΤΗΤΗ Η ΣΤΗΡΙΞΗ ΣΤΟΝ ΤΟΙΧΟ

