



# OFFICE

CHAIRS



LIBERTA

2024





# OFFICE CHAIRS

Καρέκλες εργασίας που συνδυάζουν ένα άνετο καθίσμα με εργονομικά χαρακτηριστικά, δίνοντας στους εργαζόμενους που περνούν πολλές ώρες στα γραφεία τους, την υποστήριξη που χρειάζονται για να εργαστούν αποτελεσματικά.

Τα μοντέλα που θα συναντήσετε στην συλλογή μας περιλαμβάνουν καρέκλες διευθυντικές, μοντέρνου ή κλασικού σχεδιασμού αλλά και καρέκλες εργασίας.

Διαθέτουν ρυθμιζόμενες πλάτες, καθίσματα και μπράτσα που παρέχουν στους χρήστες πλήρη έλεγχο των καθισμάτων τους.

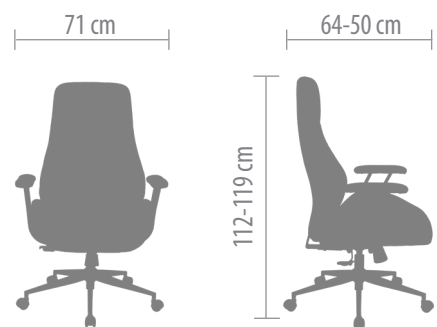

CLASS MODELS

CAMEL

25-0732

CLASS CHARACTERISTICS & POTENTIALS

CLASS WHO IS WHO

ΥΛΙΚΟ: PU  
 ΜΗΧΑΝΙΣΜΟΣ: LOCK TILT  
 ΒΑΣΗ: ΜΕΤΑΛΛΙΚΗ  
 GAS LIFT: 120mm  
 ΤΡΟΧΟΙ: 50mm RUBBER  
 ΜΕΓΙΣΤΟ ΒΑΡΟΣ: 120kg



1

ΤΕΧΤΗΤΟ ΔΕΡΜΑ  
 ΥΨΗΛΗΣ ΠΟΙΟΤΗΤΑΣ PU

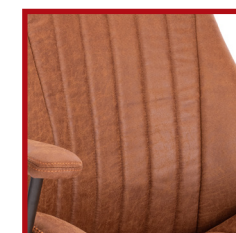

2

ΕΡΓΟΝΟΜΙΚΗ ΠΛΑΤΗ



3 4

ΜΗΧΑΝΙΣΜΟΣ ΓΙΑ  
 ΕΛΕΥΘΕΡΙΑ ΚΙΝΗΣΗΣ  
 ΠΛΑΤΗΣ ΣΕ ΘΕΣΗ RELAX ΚΑΙ  
 ΚΑΘΥΨΟΣ ΡΥΘΜΙΣΗ ΕΔΡΑΣ



5

ΜΕΤΑΛΛΙΚΗ ΑΚΤΙΝΩΤΗ ΒΑΣΗ  
 ΣΕ GUN ΧΡΩΜΑ

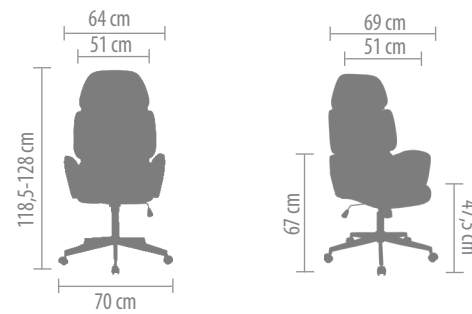

OPTIMUM MODELS

ΓΚΡΙ ΑΝΟΙΧΤΟ - ΜΑΥΡΟ 25-0620

OPTIMUM CHARACTERISTICS & POTENTIALS

OPTIMUM WHO IS WHO

ΥΛΙΚΟ: ΥΦΑΣΜΑ/ΠΛΑΣΤΙΚΟ  
 ΜΗΧΑΝΙΣΜΟΣ: LOCK TILT  
 ΒΑΣΗ: ΜΕΤΑΛΛΙΚΗ  
 GAS LIFT: 100mm  
 ΤΡΟΧΟΙ: 50mm RUBBER  
 ΜΕΓΙΣΤΟ ΒΑΡΟΣ: 120kg



1  
ΜΟΝΤΕΡΝΟΣ ΣΧΕΔΙΑΣΜΟΣ



2 3  
ΕΡΓΟΝΟΜΙΚΗ ΠΛΑΤΗ



4 5  
ΜΗΧΑΝΙΣΜΟΣ ΓΙΑ  
ΕΛΕΥΘΕΡΙΑ ΚΙΝΗΣΗΣ  
ΠΛΑΤΗΣ ΣΕ ΘΕΣΗ RELAX ΚΑΙ  
ΚΑΘΥΨΟΣ ΡΥΘΜΙΣΗ ΕΔΡΑΣ



6  
ΜΕΤΑΛΛΙΚΗ ΑΚΤΙΝΩΤΗ  
ΒΑΣΗ ΧΡΩΜΙΟΥ

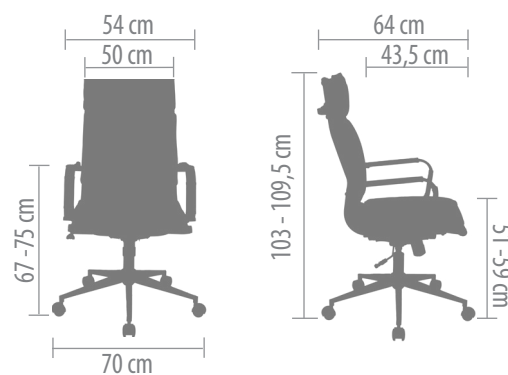

ELITE MODELS

MAYPO - GUN	25-0559
ΛΕΥΚΟ - GUN	25-0566

ELITE CHARACTERISTICS & POTENTIALS

ELITE WHO IS WHO

ΥΛΙΚΟ:	PU
ΜΗΧΑΝΙΣΜΟΣ:	LOCK TILT
ΒΑΣΗ:	ΜΕΤΑΛΛΙΚΗ
GAS LIFT:	80mm
ΤΡΟΧΟΙ:	50mm RUBBER
ΜΕΓΙΣΤΟ ΒΑΡΟΣ:	120kg



1

ΤΕΧΤΗΤΟ ΔΕΡΜΑ  
ΥΨΗΛΗΣ ΠΟΙΟΤΗΤΑΣ PU



2

ΨΗΛΗ ΠΛΑΤΗ



3 4

ΜΗΧΑΝΙΣΜΟΣ ΓΙΑ  
ΕΛΕΥΘΕΡΙΑ ΚΙΝΗΣΗΣ  
ΠΛΑΤΗΣ ΣΕ ΘΕΣΗ RELAX ΚΑΙ  
ΚΑΘΥΨΟΣ ΡΥΘΜΙΣΗ ΕΔΡΑΣ



5

ΜΕΤΑΛΛΙΚΗ ΑΚΤΙΝΩΤΗ ΒΑΣΗ  
ΣΕ GUN ΧΡΩΜΑ

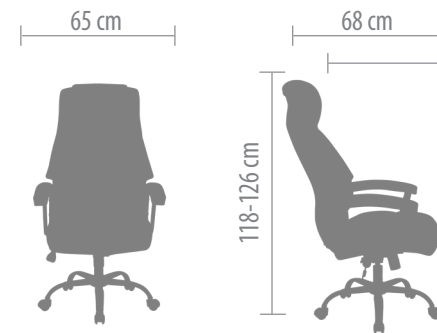

EXECUTIVE MODELS

MAYPO

25-0733

EXECUTIVE WHO IS WHO

ΥΛΙΚΟ: PU  
 ΜΗΧΑΝΙΣΜΟΣ: LOCK TILT  
 ΒΑΣΗ: ΜΕΤΑΛΛΙΚΗ  
 GAS LIFT: 120mm  
 ΤΡΟΧΟΙ: 50mm RUBBER  
 ΜΕΓΙΣΤΟ ΒΑΡΟΣ: 120kg



1

ΤΕΧΤΗΤΟ ΔΕΡΜΑ  
 ΥΨΗΛΗΣ ΠΟΙΟΤΗΤΑΣ PU



2 3

ΜΗΧΑΝΙΣΜΟΣ ΓΙΑ  
 ΕΛΕΥΘΕΡΙΑ ΚΙΝΗΣΗΣ  
 ΠΛΑΤΗΣ ΣΕ ΘΕΣΗ RELAX ΚΑΙ  
 ΚΑΘΥΨΟΣ ΡΥΘΜΙΣΗ ΕΔΡΑΣ



4

ΜΕΤΑΛΛΙΚΗ ΑΚΤΙΝΩΤΗ ΒΑΣΗ  
 ΧΡΩΜΙΟΥ



SPRING PACKAGE ΚΑΘΙΣΜΑ

EXECUTIVE CHARACTERISTICS & POTENTIALS



PATRON MODELS

CAMEL - ΜΑΥΡΟ 25-0628

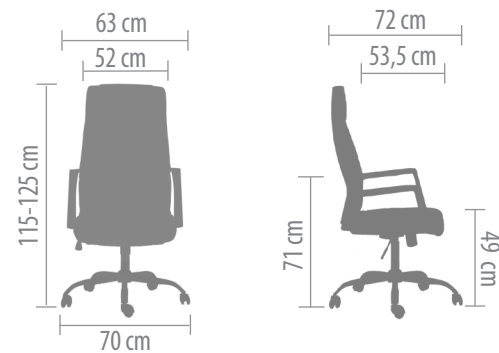

PATRON CHARACTERISTICS & POTENTIALS

PATRON WHO IS WHO

ΥΛΙΚΟ: PU  
 ΜΗΧΑΝΙΣΜΟΣ: LOCK TILT  
 ΒΑΣΗ: ΜΕΤΑΛΛΙΚΗ  
 GAS LIFT: 100mm  
 ΤΡΟΧΟΙ: 50mm RUBBER  
 ΜΕΓΙΣΤΟ ΒΑΡΟΣ: 120kg



1  
 ΤΕΧΤΗΤΟ ΔΕΡΜΑ  
 ΥΨΗΛΗΣ ΠΟΙΟΤΗΤΑΣ PU

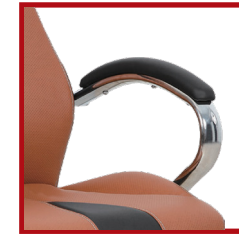

2  
 ΜΕΤΑΛΛΙΚΑ ΜΠΡΑΤΣΑ ΧΡΩΜΙΟΥ  
 ΕΠΕΝΔΥΜΕΝΑ ΜΕ PU



3 4  
 ΜΗΧΑΝΙΣΜΟΣ ΓΙΑ  
 ΕΛΕΥΘΕΡΙΑ ΚΙΝΗΣΗΣ  
 ΠΛΑΤΗΣ ΣΕ ΘΕΣΗ RELAX ΚΑΙ  
 ΚΑΘΥΨΟΣ ΡΥΘΜΙΣΗ ΕΔΡΑΣ



5  
 ΜΕΤΑΛΛΙΚΗ ΑΚΤΙΝΩΤΗ ΒΑΣΗ  
 ΣΕ GUN ΧΡΩΜΑ

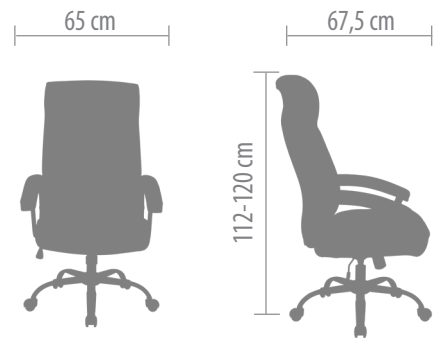

COMFY CHARACTERISTICS & POTENTIALS

COMFY WHO IS WHO

ΥΛΙΚΟ: PU  
 ΜΗΧΑΝΙΣΜΟΣ: LOCK TILT  
 ΒΑΣΗ: ΜΕΤΑΛΛΙΚΗ  
 GAS LIFT: 120mm  
 ΤΡΟΧΟΙ: 50mm RUBBER  
 ΜΕΓΙΣΤΟ ΒΑΡΟΣ: 120kg



1

ΤΕΧΤΗΤΟ ΔΕΡΜΑ  
 ΥΨΗΛΗΣ ΠΟΙΟΤΗΤΑΣ PU

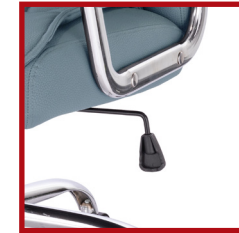

2 3

ΜΗΧΑΝΙΣΜΟΣ ΓΙΑ  
 ΕΛΕΥΘΕΡΙΑ ΚΙΝΗΣΗΣ  
 ΠΛΑΤΗΣ ΣΕ ΘΕΣΗ RELAX ΚΑΙ  
 ΚΑΘΥΨΟΣ ΡΥΘΜΙΣΗ ΕΔΡΑΣ



4

ΜΕΤΑΛΛΙΚΗ ΑΚΤΙΝΩΤΗ ΒΑΣΗ  
 ΧΡΩΜΙΟΥ



SPRING PACKAGE ΚΑΘΙΣΜΑ

COMFY MODELS

BLUE	25-0734
CAMEL	25-0736





**BOSS MODELS**

BLACK	25-0555
CAMEL	25-0597

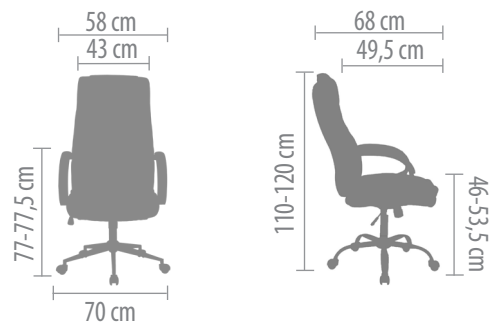

BOSS CHARACTERISTICS & POTENTIALS

**BOSS WHO IS WHO**

**ΥΛΙΚΟ:** WAX PU  
**ΜΗΧΑΝΙΣΜΟΣ:** LOCK TILT  
**ΒΑΣΗ:** ΜΕΤΑΛΛΙΚΗ  
**GAS LIFT:** 80mm  
**ΤΡΟΧΟΙ:** 50mm RUBBER  
**ΜΕΓΙΣΤΟ ΒΑΡΟΣ:** 120kg



**1**  
 ΤΕΧΤΗΤΟ ΔΕΡΜΑ  
 ΥΨΗΛΗΣ ΠΟΙΟΤΗΤΑΣ  
 WAX PU



**2 3**  
 ΕΡΓΟΝΟΜΙΚΗ ΠΛΑΤΗ  
 ΕΠΕΝΔΥΜΕΝΑ ΜΠΡΑΤΣΑ



**4 5**  
 ΜΗΧΑΝΙΣΜΟΣ ΓΙΑ  
 ΕΛΕΥΘΕΡΙΑ ΚΙΝΗΣΗΣ  
 ΠΛΑΤΗΣ ΣΕ ΘΕΣΗ RELAX ΚΑΙ  
 ΚΑΘΥΨΟΣ ΡΥΘΜΙΣΗ ΕΔΡΑΣ



**6**  
 ΜΕΤΑΛΛΙΚΗ ΑΚΤΙΝΩΤΗ ΒΑΣΗ  
 ΣΕ GUN ΧΡΩΜΑ



SCELETON MODELS

ΑΝΘΡΑΚΙ 25-0621

SCELETON WHO IS WHO

ΥΛΙΚΟ: ΥΦΑΣΜΑ/ΠΛΑΣΤΙΚΟ  
 ΜΗΧΑΝΙΣΜΟΣ: LOCK TILT  
 ΒΑΣΗ: NYLON  
 GAS LIFT: 100mm  
 ΤΡΟΧΟΙ: 50mm RUBBER  
 ΜΕΓΙΣΤΟ ΒΑΡΟΣ: 120kg



1

PP ΠΛΑΤΗ & ΜΠΡΑΤΣΑ



2

ΕΡΓΟΝΟΜΙΚΑ ΜΠΡΑΤΣΑ



3 4

ΜΗΧΑΝΙΣΜΟΣ ΓΙΑ ΕΛΕΥΘΕΡΙΑ ΚΙΝΗΣΗΣ ΠΛΑΤΗΣ ΣΕ ΘΕΣΗ RELAX ΚΑΙ ΚΑΘΥΨΟΣ ΡΥΘΜΙΣΗ ΕΔΡΑΣ



5

NYLON ΑΚΤΙΝΩΤΗ ΒΑΣΗ ΣΕ ΜΑΥΡΟ ΧΡΩΜΑ

SCELETON CHARACTERISTICS & POTENTIALS

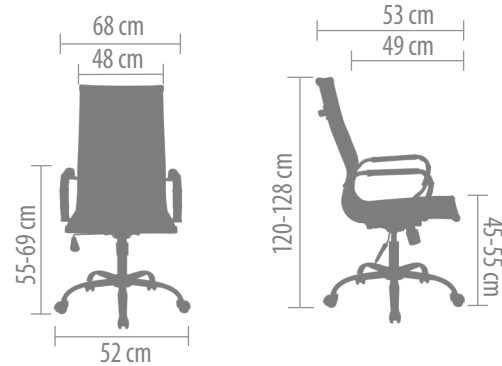

AVANT MODELS

ΑΝΘΡΑΚΙ - ΜΑΥΡΟ	25-0514
COFFEE - GUN	25-0554

AVANT WHO IS WHO

ΥΛΙΚΟ:	WAX PU
ΜΗΧΑΝΙΣΜΟΣ:	LOCK TILT
ΒΑΣΗ:	ΜΕΤΑΛΛΙΚΗ
GAS LIFT:	80mm
ΤΡΟΧΟΙ:	50mm RUBBER
ΜΕΓΙΣΤΟ ΒΑΡΟΣ:	120kg



1  
ΤΕΧΤΗΤΟ ΔΕΡΜΑ  
ΥΨΗΛΗΣ ΠΟΙΟΤΗΤΑΣ  
WAX PU



2 3  
ΕΡΓΟΝΟΜΙΚΗ ΠΛΑΤΗ  
ΕΠΕΝΔΥΜΕΝΑ ΜΠΡΑΤΣΑ



4 5  
ΜΗΧΑΝΙΣΜΟΣ ΓΙΑ  
ΕΛΕΥΘΕΡΙΑ ΚΙΝΗΣΗΣ  
ΠΛΑΤΗΣ ΣΕ ΘΕΣΗ RELAX ΚΑΙ  
ΚΑΘΥΨΟΣ ΡΥΘΜΙΣΗ ΕΔΡΑΣ



6  
ΜΕΤΑΛΛΙΚΗ ΑΚΤΙΝΩΤΗ ΒΑΣΗ  
ΣΕ GUN ΧΡΩΜΑ

AVANT CHARACTERISTICS & POTENTIALS



CAROL MODELS

MAYPO 25-0570

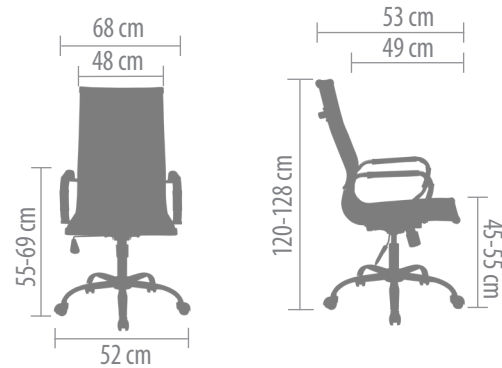

CAROL CHARACTERISTICS & POTENTIALS

CAROL WHO IS WHO

ΥΛΙΚΟ: PU  
 ΜΗΧΑΝΙΣΜΟΣ: LOCK TILT  
 ΒΑΣΗ: ΜΕΤΑΛΛΙΚΗ  
 GAS LIFT: 80mm  
 ΤΡΟΧΟΙ: 50mm RUBBER  
 ΜΕΓΙΣΤΟ ΒΑΡΟΣ: 120kg



1  
 ΤΕΧΤΗΤΟ ΔΕΡΜΑ  
 ΥΨΗΛΗΣ ΠΟΙΟΤΗΤΑΣ  
 PU



2 3  
 ΕΡΓΟΝΟΜΙΚΗ ΠΛΑΤΗ  
 ΕΠΕΝΔΥΜΕΝΑ ΜΠΡΑΤΣΑ



4 5  
 ΜΗΧΑΝΙΣΜΟΣ ΓΙΑ  
 ΕΛΕΥΘΕΡΙΑ ΚΙΝΗΣΗΣ  
 ΠΛΑΤΗΣ ΣΕ ΘΕΣΗ RELAX ΚΑΙ  
 ΚΑΘΥΨΟΣ ΡΥΘΜΙΣΗ ΕΔΡΑΣ



6  
 ΜΕΤΑΛΛΙΚΗ ΑΚΤΙΝΩΤΗ ΒΑΣΗ  
 ΧΡΩΜΙΟΥ



AVENGER MODELS

XAKI - ΜΑΥΡΟ 25-0517

SPIRIT WHO IS WHO

ΥΛΙΚΟ: PU  
 ΜΗΧΑΝΙΣΜΟΣ: LOCK TILT  
 ΒΑΣΗ: NYLON  
 GAS LIFT: 80mm  
 ΤΡΟΧΟΙ: 50mm RUBBER  
 ΜΕΓΙΣΤΟ ΒΑΡΟΣ: 120kg



1  
 ΑΠΟΣΠΩΜΕΝΟ ΜΑΞΙΛΑΡΑΚΙ  
 ΠΡΟΣΚΕΦΑΛΟΥ  
 ΑΠΟΣΠΩΜΕΝΟ ΜΑΞΙΛΑΡΑΚΙ  
 ΜΕΣΗΣ



2  
 ΡΥΘΜΙΖΟΜΕΝΑ ΜΠΡΑΤΣΑ

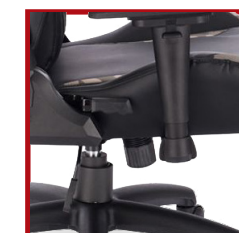

3 4  
 ΜΗΧΑΝΙΣΜΟΣ ΓΙΑ  
 ΕΛΕΥΘΕΡΙΑ ΚΙΝΗΣΗΣ  
 ΠΛΑΤΗΣ ΣΕ ΘΕΣΗ RELAX ΚΑΙ  
 ΚΑΘΥΨΟΣ ΡΥΘΜΙΣΗ ΕΔΡΑΣ



5  
 NYLON ΑΚΤΙΝΩΤΗ ΒΑΣΗ ΣΕ  
 ΜΑΥΡΟ ΧΡΩΜΑ

SPIRIT CHARACTERISTICS & POTENTIALS

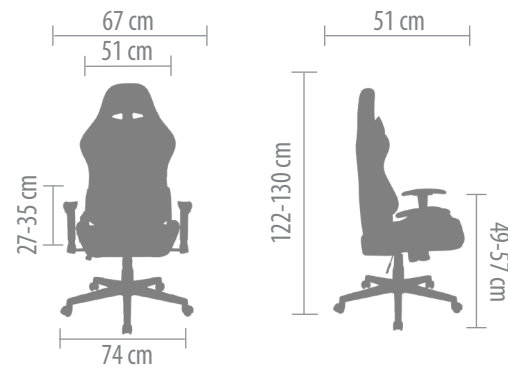

MAXIMUS MODELS

MAYPO ME LED

25-0706

MAXIMUS CHARACTERISTICS & POTENTIALS

MAXIMUS WHO IS WHO

ΥΛΙΚΟ: PU  
 ΜΗΧΑΝΙΣΜΟΣ: LOCK TILT  
 ΒΑΣΗ: NYLON  
 GAS LIFT: 80mm  
 ΤΡΟΧΟΙ: 50mm RUBBER  
 ΜΕΓΙΣΤΟ ΒΑΡΟΣ: 136 kg

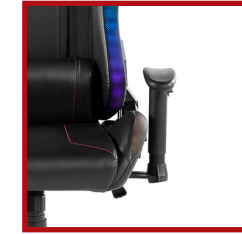

1

ΡΥΘΜΙΖΟΜΕΝΑ ΜΠΡΑΤΣΑ



2

ΕΡΓΟΝΟΜΙΚΗ ΠΛΑΤΗ



3 4

ΜΗΧΑΝΙΣΜΟΣ ΓΙΑ ΕΛΕΥΘΕΡΙΑ ΚΙΝΗΣΗΣ ΠΛΑΤΗΣ ΣΕ ΘΕΣΗ RELAX ΚΑΙ ΚΑΘΥΨΟΣ ΡΥΘΜΙΣΗ ΕΔΡΑΣ



5

NYLON ΑΚΤΙΝΩΤΗ ΒΑΣΗ ΣΕ ΜΑΥΡΟ ΧΡΩΜΑ



RANGER MODELS

MAYPO	25-0707
MAYPO - KITPINO	25-0708
MAYPO - PURO	25-0709

RANGER WHO IS WHO

ΥΛΙΚΟ:	PU
ΜΗΧΑΝΙΣΜΟΣ:	LOCK TILT
ΒΑΣΗ:	NYLON
GAS LIFT:	100mm
ΤΡΟΧΟΙ:	60mm RUBBER
ΜΕΓΙΣΤΟ ΒΑΡΟΣ:	136kg



1

ΡΥΘΜΙΖΟΜΕΝΑ ΜΠΡΑΤΣΑ

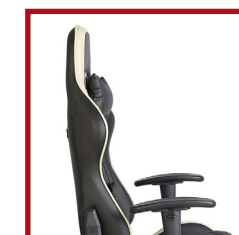

2

ΕΡΓΟΝΟΜΙΚΗ ΠΛΑΤΗ



3 4

ΜΗΧΑΝΙΣΜΟΣ ΓΙΑ ΕΛΕΥΘΕΡΙΑ ΚΙΝΗΣΗΣ ΠΛΑΤΗΣ ΣΕ ΘΕΣΗ RELAX ΚΑΙ ΚΑΘΥΨΟΣ ΡΥΘΜΙΣΗ ΕΔΡΑΣ



5

NYLON ΑΚΤΙΝΩΤΗ ΒΑΣΗ ΣΕ ΜΑΥΡΟ ΧΡΩΜΑ

RANGER CHARACTERISTICS & POTENTIALS

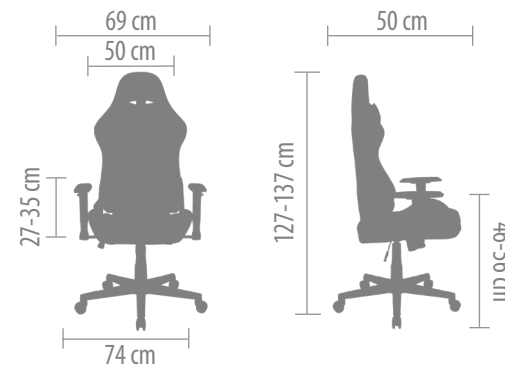

**DYSKORD MODELS**

ΧΑΚΙ - ΜΑΥΡΟ  
ΠΟΡΤΟΚΑΛΙ - ΜΑΥΡΟ

25-0710  
25-0711

DYSKORD CHARACTERISTICS & POTENTIALS

**DYSKORD WHO IS WHO**

ΥΛΙΚΟ: PU  
ΜΗΧΑΝΙΣΜΟΣ: LOCK TILT  
ΒΑΣΗ: NYLON  
GAS LIFT: 100mm  
ΤΡΟΧΟΙ: 60mm RUBBER  
ΜΕΓΙΣΤΟ ΒΑΡΟΣ: 136kg

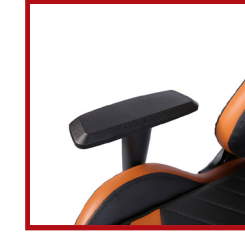

1

ΡΥΘΜΙΖΟΜΕΝΑ ΜΠΡΑΤΣΑ

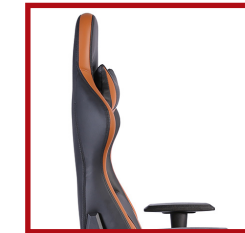

2

ΕΡΓΟΝΟΜΙΚΗ ΠΛΑΤΗ



3 4

ΜΗΧΑΝΙΣΜΟΣ ΓΙΑ  
ΕΛΕΥΘΕΡΙΑ ΚΙΝΗΣΗΣ  
ΠΛΑΤΗΣ ΣΕ ΘΕΣΗ RELAX ΚΑΙ  
ΚΑΘΥΨΟΣ ΡΥΘΜΙΣΗ ΕΔΡΑΣ



5

NYLON ΑΚΤΙΝΩΤΗ ΒΑΣΗ ΣΕ  
ΜΑΥΡΟ ΧΡΩΜΑ





**STORM MODELS**

KOKKINO - ΜΑΥΡΟ ΜΕ LED

25-0705

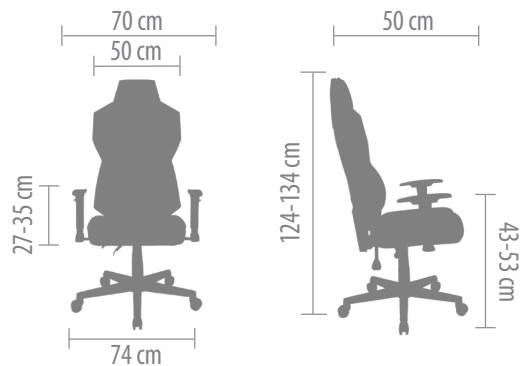

STORM CHARACTERISTICS & POTENTIALS

**STORM WHO IS WHO**

**ΥΛΙΚΟ:** PU & MESH  
**ΜΗΧΑΝΙΣΜΟΣ:** LOCK TILT  
**ΒΑΣΗ:** NYLON  
**GAS LIFT:** 100mm  
**ΤΡΟΧΟΙ:** 60mm RUBBER  
**ΜΕΓΙΣΤΟ ΒΑΡΟΣ:** 136kg



1

ΡΥΘΜΙΖΟΜΕΝΑ ΜΠΡΑΤΣΑ



2

ΕΡΓΟΝΟΜΙΚΗ ΠΛΑΤΗ



3 4

ΜΗΧΑΝΙΣΜΟΣ ΓΙΑ ΕΛΕΥΘΕΡΙΑ ΚΙΝΗΣΗΣ ΠΛΑΤΗΣ ΣΕ ΘΕΣΗ RELAX ΚΑΙ ΚΑΘΥΨΟΣ ΡΥΘΜΙΣΗ ΕΔΡΑΣ



5

NYLON ΑΚΤΙΝΩΤΗ ΒΑΣΗ ΣΕ ΜΑΥΡΟ ΧΡΩΜΑ

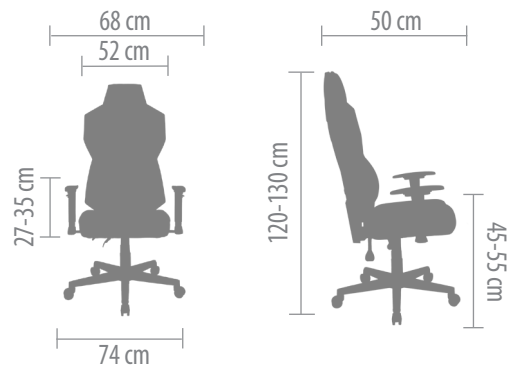

EXPLOR MODELS

MAYPO - ΓΚΡΙ  
MOCCA - GREZ

25-0703  
25-0704

EXPLOR CHARACTERISTICS & POTENTIALS

EXPLOR WHO IS WHO

ΥΛΙΚΟ: PU  
ΜΗΧΑΝΙΣΜΟΣ: LOCK TILT  
ΒΑΣΗ: NYLON  
GAS LIFT: 100mm  
ΤΡΟΧΟΙ: 60mm RUBBER  
ΜΕΓΙΣΤΟ ΒΑΡΟΣ: 136kg

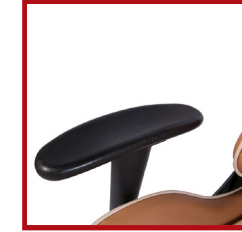

1

ΡΥΘΜΙΖΟΜΕΝΑ ΜΠΡΑΤΣΑ



2

ΕΡΓΟΝΟΜΙΚΗ ΠΛΑΤΗ

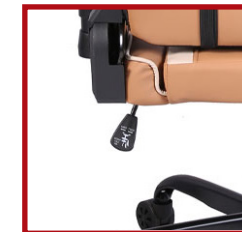

3 4

ΜΗΧΑΝΙΣΜΟΣ ΓΙΑ  
ΕΛΕΥΘΕΡΙΑ ΚΙΝΗΣΗΣ  
ΠΛΑΤΗΣ ΣΕ ΘΕΣΗ RELAX ΚΑΙ  
ΚΑΘΥΨΟΣ ΡΥΘΜΙΣΗ ΕΔΡΑΣ



5

NYLON ΑΚΤΙΝΩΤΗ ΒΑΣΗ ΣΕ  
ΜΑΥΡΟ ΧΡΩΜΑ

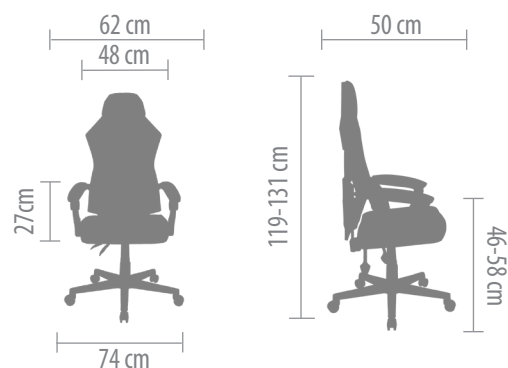

FUSION MODELS

MAYPO	25-0700
MAYPO - ΜΠΛΕ	25-0701
MAYPO - ΚΟΚΚΙΝΟ	25-0702

FUSION CHARACTERISTICS & POTENTIALS

FUSION WHO IS WHO

ΥΛΙΚΟ: PU & MESH  
 ΜΗΧΑΝΙΣΜΟΣ: LOCK TILT  
 ΒΑΣΗ: NYLON  
 GAS LIFT: 120mm  
 ΤΡΟΧΟΙ: 60mm RUBBER  
 ΜΕΓΙΣΤΟ ΒΑΡΟΣ: 136kg

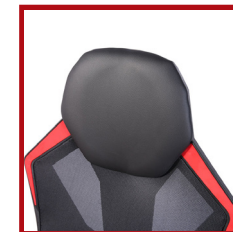

1

ΤΕΧΤΗΤΟ ΔΕΡΜΑ  
ΥΨΗΛΗΣ ΠΟΙΟΤΗΤΑΣ PU

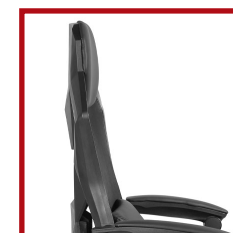

2

ΕΡΓΟΝΟΜΙΚΗ ΠΛΑΤΗ



3 4

ΜΗΧΑΝΙΣΜΟΣ ΓΙΑ  
ΕΛΕΥΘΕΡΙΑ ΚΙΝΗΣΗΣ  
ΠΛΑΤΗΣ ΣΕ ΘΕΣΗ RELAX ΚΑΙ  
ΚΑΘΥΨΟΣ ΡΥΘΜΙΣΗ ΕΔΡΑΣ



5

NYLON ΑΚΤΙΝΩΤΗΒΑΣΗ  
ΜΑΥΡΟ & ΚΟΚΚΙΝΟ ΧΡΩΜΑ

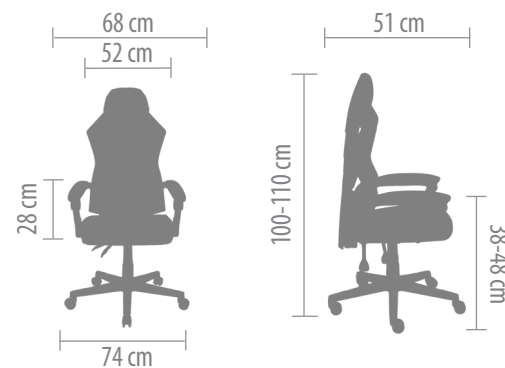

**OUTRIDER MODELS**

MAYPO	25-0699
MAYPO - KOKKINO	25-0698

OUTRIDER CHARACTERISTICS & POTENTIALS

**OUTRIDER WHO IS WHO**

<b>ΥΛΙΚΟ:</b>	PU & MESH
<b>ΜΗΧΑΝΙΣΜΟΣ:</b>	LOCK TILT
<b>ΒΑΣΗ:</b>	NYLON
<b>GAS LIFT:</b>	100mm
<b>ΤΡΟΧΟΙ:</b>	60mm RUBBER
<b>ΜΕΓΙΣΤΟ ΒΑΡΟΣ:</b>	136kg



1

ΤΕΧΤΗΤΟ ΔΕΡΜΑ  
ΥΨΗΛΗΣ ΠΟΙΟΤΗΤΑΣ PU



2

ΕΡΓΟΝΟΜΙΚΗ ΠΛΑΤΗ



3 4

ΜΗΧΑΝΙΣΜΟΣ ΓΙΑ  
ΕΛΕΥΘΕΡΙΑ ΚΙΝΗΣΗΣ  
ΠΛΑΤΗΣ ΣΕ ΘΕΣΗ RELAX ΚΑΙ  
ΚΑΘΥΨΟΣ ΡΥΘΜΙΣΗ ΕΔΡΑΣ



5

NYLON ΑΚΤΙΝΩΤΗ ΒΑΣΗ ΣΕ  
ΜΑΥΡΟ & ΚΟΚΚΙΝΟ ΧΡΩΜΑ

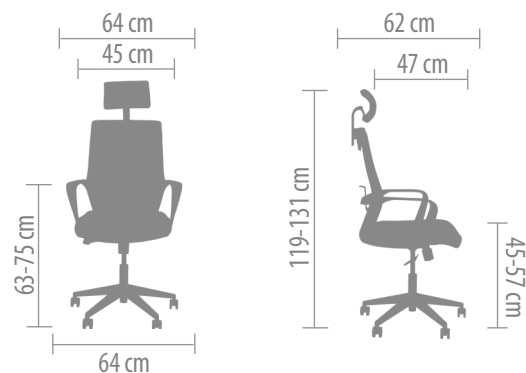

PANTONE MODELS

ΧΡΥΣΟ	25-0619
ΓΚΡΙ	25-0613
ΜΠΛΕ OCEAN	25-0618

PANTONE CHARACTERISTICS & POTENTIALS

PANTONE WHO IS WHO

ΥΛΙΚΟ: MESH/ΥΦΑΣΜΑ  
 ΜΗΧΑΝΙΣΜΟΣ: LOCK TILT  
 ΒΑΣΗ: NYLON  
 GAS LIFT: 120mm  
 ΤΡΟΧΟΙ: 50mm RUBBER  
 ΜΕΓΙΣΤΟ ΒΑΡΟΣ: 120kg



1

ΑΦΑΙΡΟΥΜΕΝΟ ΠΡΟΣΚΕΦΑΛΟ

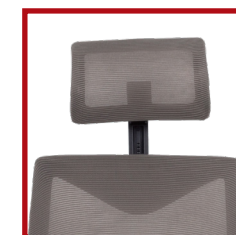

2

ΥΦΑΣΜΑ MESH ΓΙΑ ΤΗΝ ΚΑΛΗ ΚΥΚΛΟΦΟΡΙΑ ΤΟΥ ΑΕΡΑ  
 ΙΔΑΝΙΚΗ ΓΙΑ ΠΟΛΥΩΡΗ ΕΡΓΑΣΙΑ



3 4

ΜΗΧΑΝΙΣΜΟΣ ΓΙΑ ΕΛΕΥΘΕΡΙΑ ΚΙΝΗΣΗΣ ΠΛΑΤΗΣ ΣΕ ΘΕΣΗ RELAX ΚΑΙ ΚΑΘΥΨΟΣ ΡΥΘΜΙΣΗ ΕΔΡΑΣ



5

NYLON ΑΚΤΙΝΩΤΗ ΒΑΣΗ ΣΕ ΜΑΥΡΟ ΧΡΩΜΑ

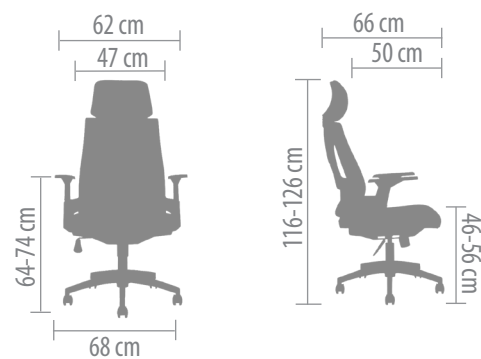

**TIE MODELS**

ΜΑΥΡΟ	25-0612
ΜΠΛΕ - ΜΑΥΡΟ	25-0617

**TIE WHO IS WHO**

**ΥΛΙΚΟ:** MESH / ΥΦΑΣΜΑ  
**ΜΗΧΑΝΙΣΜΟΣ:** LOCK TILT  
**ΒΑΣΗ:** NYLON  
**GAS LIFT:** 100mm  
**ΤΡΟΧΟΙ:** 55mm RUBBER  
**ΜΕΓΙΣΤΟ ΒΑΡΟΣ:** 155kg

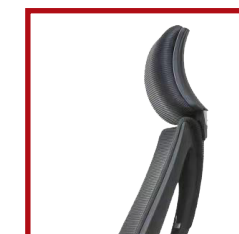

1

ΣΤΑΘΕΡΟ ΠΡΟΣΚΕΦΑΛΟ



2

ΕΡΓΟΝΟΜΙΚΗ ΠΛΑΤΗ ΜΕ ΡΥΘΜΙΖΟΜΕΝΗ ΥΠΟΣΤΗΡΙΞΗ ΜΕΣΗΣ



3 4

ΜΗΧΑΝΙΣΜΟΣ ΓΙΑ ΕΛΕΥΘΕΡΙΑ ΚΙΝΗΣΗΣ ΠΛΑΤΗΣ ΣΕ ΘΕΣΗ RELAX ΚΑΙ ΚΑΘΥΨΟΣ ΡΥΘΜΙΣΗ ΕΔΡΑΣ



5

NYLON ΑΚΤΙΝΩΤΗ ΒΑΣΗ ΣΕ ΜΑΥΡΟ ΧΡΩΜΑ

TIE CHARACTERISTICS & POTENTIALS

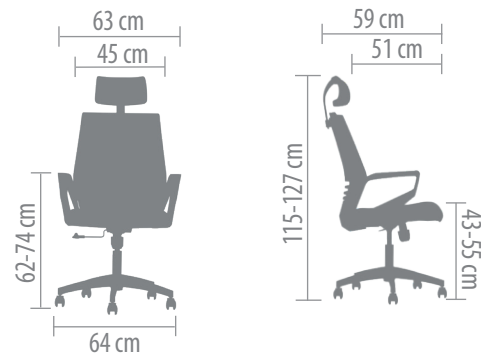

VITRIO MODELS

ΜΑΥΡΟ	25-0610
ΓΚΡΙ - ΜΠΛΕ	25-0616

VITRIO WHO IS WHO

ΥΛΙΚΟ: MESH / ΥΦΑΣΜΑ  
 ΜΗΧΑΝΙΣΜΟΣ: LOCK TILT  
 ΒΑΣΗ: NYLON  
 GAS LIFT: 120mm  
 ΤΡΟΧΟΙ: 55mm RUBBER  
 ΜΕΓΙΣΤΟ ΒΑΡΟΣ: 120kg



1  
ΑΦΑΙΡΟΥΜΕΝΟ ΠΡΟΣΚΕΦΑΛΟ



2  
ΕΡΓΟΝΟΜΙΚΗ ΠΛΑΤΗ ΜΕ ΡΥΘΜΙΖΟΜΕΝΗ ΥΠΟΣΤΗΡΙΞΗ ΜΕΣΗΣ



3 4  
ΜΗΧΑΝΙΣΜΟΣ ΓΙΑ ΕΛΕΥΘΕΡΙΑ ΚΙΝΗΣΗΣ ΠΛΑΤΗΣ ΣΕ ΘΕΣΗ RELAX ΚΑΙ ΚΑΘΥΨΟΣ ΡΥΘΜΙΣΗ ΕΔΡΑΣ



5  
NYLON ΑΚΤΙΝΩΤΗ ΒΑΣΗ ΣΕ ΜΑΥΡΟ ΧΡΩΜΑ

VITRIO CHARACTERISTICS & POTENTIALS

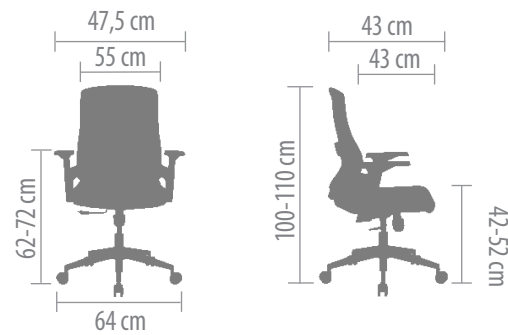

STABILO MODELS

MAYPO	25-0605
MAYPO - MPLE	25-0606

STABILO WHO IS WHO

ΥΛΙΚΟ:	MESH / ΥΦΑΣΜΑ
ΜΗΧΑΝΙΣΜΟΣ:	LOCK TILT
ΒΑΣΗ:	NYLON
GAS LIFT:	100mm
ΤΡΟΧΟΙ:	60mm RUBBER
ΜΕΓΙΣΤΟ ΒΑΡΟΣ:	120kg

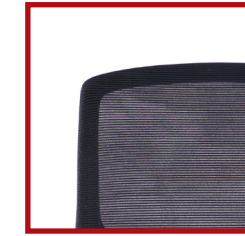

1

ΔΙΑΤΡΗΤΟ ΥΦΑΣΜΑ MESH



2

ΕΡΓΟΝΟΜΙΚΗ ΠΛΑΤΗ ΚΑΙ ΜΠΡΑΤΣΑ



3 4

ΜΗΧΑΝΙΣΜΟΣ ΓΙΑ ΕΛΕΥΘΕΡΙΑ ΚΙΝΗΣΗΣ ΠΛΑΤΗΣ ΣΕ ΘΕΣΗ RELAX ΚΑΙ ΚΑΘΥΨΟΣ ΡΥΘΜΙΣΗ ΕΔΡΑΣ



5

NYLON ΑΚΤΙΝΩΤΗ ΒΑΣΗ ΣΕ ΜΑΥΡΟ ΧΡΩΜΑ

STABILO CHARACTERISTICS & POTENTIALS



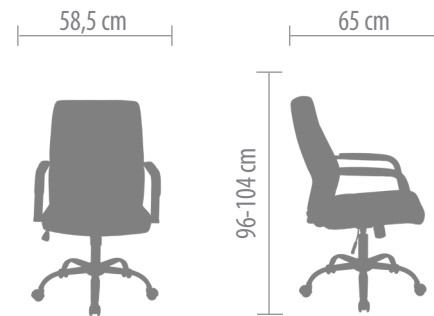

**KORD MODELS**

ΚΑΦΕ 25-0735  
 ΜΕΝΤΑ 25-0737

**KORD WHO IS WHO**

**ΥΛΙΚΟ:** PU  
**ΜΗΧΑΝΙΣΜΟΣ:** LOCK TILT  
**ΒΑΣΗ:** ΜΕΤΑΛΛΙΚΗ  
**GAS LIFT:** 120mm  
**ΤΡΟΧΟΙ:** 50mm RUBBER  
**ΜΕΓΙΣΤΟ ΒΑΡΟΣ:** 120kg



1

ΤΕΧΤΗΤΟ ΔΕΡΜΑ  
 ΥΨΗΛΗΣ ΠΟΙΟΤΗΤΑΣ PU



2 3

ΜΗΧΑΝΙΣΜΟΣ ΓΙΑ  
 ΕΛΕΥΘΕΡΙΑ ΚΙΝΗΣΗΣ  
 ΠΛΑΤΗΣ ΣΕ ΘΕΣΗ RELAX ΚΑΙ  
 ΚΑΘΥΨΟΣ ΡΥΘΜΙΣΗ ΕΔΡΑΣ



4

ΜΕΤΑΛΛΙΚΗ ΑΚΤΙΝΩΤΗ ΒΑΣΗ  
 ΣΕ GUN ΧΡΩΜΑ

KORD CHARACTERISTICS & POTENTIALS



OPRA MODELS

MAYPO	25-0609
ΓΚΡΙ	25-0615
BORDEAUX - ΓΚΡΙ	25-0614

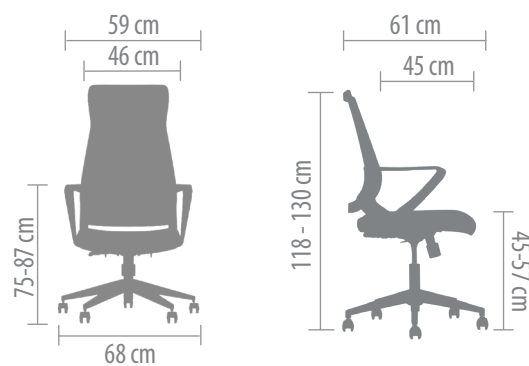

OPRA CHARACTERISTICS & POTENTIALS

OPRA WHO IS WHO

ΥΛΙΚΟ: MESH/ΥΦΑΣΜΑ  
 ΜΗΧΑΝΙΣΜΟΣ: LOCK TILT  
 ΒΑΣΗ: NYLON  
 GAS LIFT: 120mm  
 ΤΡΟΧΟΙ: 60mm RUBBER  
 ΜΕΓΙΣΤΟ ΒΑΡΟΣ: 100kg



1  
 ΥΦΑΣΜΑ MESH ΓΙΑ ΤΗΝ ΚΑΛΗ ΚΥΚΛΟΦΟΡΙΑ ΤΟΥ ΑΕΡΑ ΙΔΑΝΙΚΗ ΓΙΑ ΠΟΛΥΩΡΗ ΕΡΓΑΣΙΑ



2  
 ΕΡΓΟΝΟΜΙΚΗ ΠΛΑΤΗ



3 4  
 ΜΗΧΑΝΙΣΜΟΣ ΓΙΑ ΕΛΕΥΘΕΡΙΑ ΚΙΝΗΣΗΣ ΠΛΑΤΗΣ ΣΕ ΘΕΣΗ RELAX ΚΑΙ ΚΑΘΥΨΟΣ ΡΥΘΜΙΣΗ ΕΔΡΑΣ

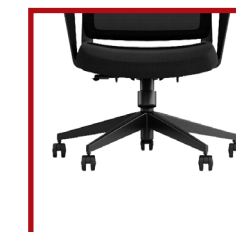

5  
 NYLON ΑΚΤΙΝΩΤΗ ΒΑΣΗ ΣΕ ΜΑΥΡΟ ΧΡΩΜΑ

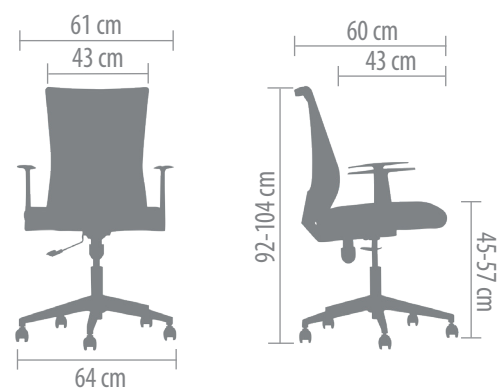

VITA MODELS

MAYPO - ALCOHOL	25-0436
MAYPO - ΓΚΡΙ	25-0437

VITA WHO IS WHO

ΥΛΙΚΟ:	MESH/ΥΦΑΣΜΑ
ΜΗΧΑΝΙΣΜΟΣ:	LOCK TILT
ΒΑΣΗ:	NYLON
GAS LIFT:	80mm
ΤΡΟΧΟΙ:	50mm RUBBER
ΜΕΓΙΣΤΟ ΒΑΡΟΣ:	180kg



1  
ΥΦΑΣΜΑ MESH ΓΙΑ ΤΗΝ ΚΑΛΗ ΚΥΚΛΟΦΟΡΙΑ ΤΟΥ ΑΕΡΑ ΙΔΑΝΙΚΗ ΓΙΑ ΠΟΛΥΩΡΗ ΕΡΓΑΣΙΑ



2  
ΕΡΓΟΝΟΜΙΚΗ ΠΛΑΤΗ



3 4  
ΜΗΧΑΝΙΣΜΟΣ ΓΙΑ ΕΛΕΥΘΕΡΙΑ ΚΙΝΗΣΗΣ ΠΛΑΤΗΣ ΣΕ ΘΕΣΗ RELAX ΚΑΙ ΚΑΘΥΨΟΣ ΡΥΘΜΙΣΗ ΕΔΡΑΣ



5  
NYLON ΑΚΤΙΝΩΤΗ ΒΑΣΗ ΣΕ ΜΑΥΡΟ ΧΡΩΜΑ

VITA CHARACTERISTICS & POTENTIALS



SHARP MODELS

MAYPO

25-0567

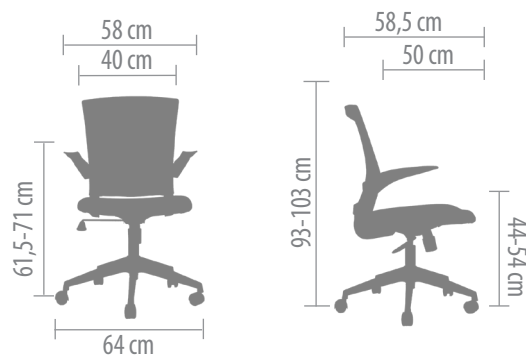

SHARP CHARACTERISTICS & POTENTIALS

SHARP WHO IS WHO

ΥΛΙΚΟ: MESH/ΥΦΑΣΜΑ  
 ΜΗΧΑΝΙΣΜΟΣ: LOCK TILT  
 ΒΑΣΗ: NYLON  
 GAS LIFT: 100mm  
 ΤΡΟΧΟΙ: 50mm RUBBER  
 ΜΕΓΙΣΤΟ ΒΑΡΟΣ: 100kg



1

ΠΛΑΤΗ ΑΠΟ ΥΦΑΣΜΑ MESH ΓΙΑ ΤΗΝ ΚΑΛΗ ΚΥΚΛΟΦΟΡΙΑ ΤΟΥ ΑΕΡΑ ΙΔΑΝΙΚΗ ΓΙΑ ΠΟΛΥΩΡΗ ΕΡΓΑΣΙΑ



2

ΑΝΑΚΛΙΝΟΜΕΝΑ ΜΠΡΑΤΣΑ



3 4

ΜΗΧΑΝΙΣΜΟΣ ΓΙΑ ΕΛΕΥΘΕΡΙΑ ΚΙΝΗΣΗΣ ΠΛΑΤΗΣ ΣΕ ΘΕΣΗ RELAX ΚΑΙ ΚΑΘΥΨΟΣ ΡΥΘΜΙΣΗ ΕΔΡΑΣ



5

NYLON ΑΚΤΙΝΩΤΗ ΒΑΣΗ ΣΕ ΜΑΥΡΟ ΧΡΩΜΑ

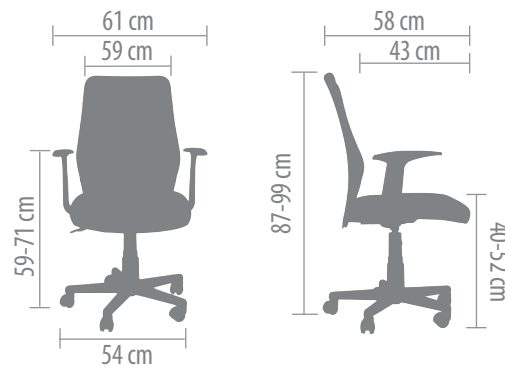

ERGO MODELS

MAYPO

25-0571

ERGO CHARACTERISTICS & POTENTIALS

ERGO WHO IS WHO

ΥΛΙΚΟ: PU  
 ΜΗΧΑΝΙΣΜΟΣ: UP & DOWN  
 ΒΑΣΗ: NYLON  
 GAS LIFT: 120mm  
 ΤΡΟΧΟΙ: 50mm RUBBER  
 ΜΕΓΙΣΤΟ ΒΑΡΟΣ: 90kg



1

ΤΕΧΤΗΤΟ ΔΕΡΜΑ  
 ΥΨΗΛΗΣ ΠΟΙΟΤΗΤΑΣ PU



2

ΕΡΓΟΝΟΜΙΚΗ ΠΛΑΤΗ



3

ΜΗΧΑΝΙΣΜΟΣ ΓΙΑ ΚΑΘΥΨΟΣ  
 ΡΥΘΜΙΣΗ ΕΔΡΑΣ



4

NYLON ΑΚΤΙΝΩΤΗ ΒΑΣΗ ΣΕ  
 ΜΑΥΡΟ ΧΡΩΜΑ

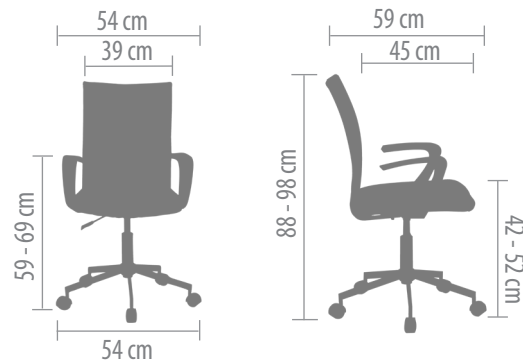

LOTTO MODELS

ΓΚΡΙ	25-0472
MIDNIGHT BLUE	25-0473
DUSTY PINK	25-0474
KITPINO	25-0542

LOTTO CHARACTERISTICS & POTENTIALS

LOT WHO IS WHO

ΥΛΙΚΟ: ΒΕΛΟΥΔΟ  
 ΜΗΧΑΝΙΣΜΟΣ: UP & DOWN  
 ΒΑΣΗ: ΜΕΤΑΛΛΙΚΗ  
 GAS LIFT: 80mm  
 ΤΡΟΧΟΙ: 50mm RUBBER  
 ΜΕΓΙΣΤΟ ΒΑΡΟΣ: 90kg

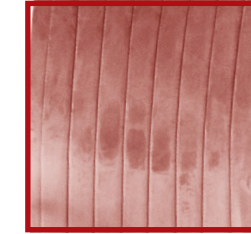

1

ΒΕΛΟΥΔΟ



2 3

ΕΡΓΟΝΟΜΙΚΗ ΠΛΑΤΗ  
 ΜΠΡΑΤΣΑ ΜΟΝΤΕΡΝΟΥ  
 ΣΧΕΔΙΑΣΜΟΥ



4

ΜΗΧΑΝΙΣΜΟΣ ΓΙΑ ΚΑΘΥΨΟΣ  
 ΡΥΘΜΙΣΗ ΕΔΡΑΣ



5

ΜΕΤΑΛΛΙΚΗ ΑΚΤΙΝΩΤΗ  
 ΒΑΣΗ ΧΡΩΜΙΟΥ

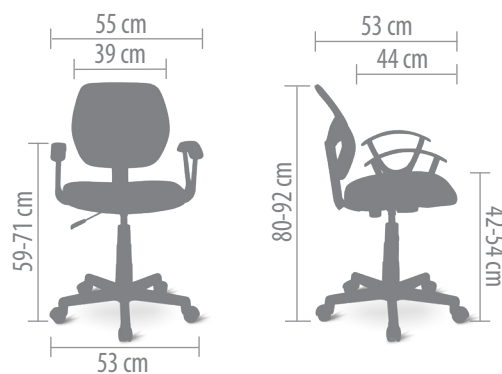

STRIPES MODELS

ΜΑΥΡΟ	25-0230
ΚΟΚΚΙΝΟ - ΜΑΥΡΟ	25-0231
ΜΩΒ - ΜΑΥΡΟ	25-0234
ΜΠΛΕ - ΜΑΥΡΟ	25-0374

STRIPES CHARACTERISTICS & POTENTIALS

STRIPES WHO IS WHO

ΥΛΙΚΟ: MESH/ΥΦΑΣΜΑ  
 ΜΗΧΑΝΙΣΜΟΣ: UP & DOWN  
 ΒΑΣΗ: NYLON  
 GAS LIFT: 80mm  
 ΤΡΟΧΟΙ: 50mm RUBBER  
 ΜΕΓΙΣΤΟ ΒΑΡΟΣ: 100kg



1

ΠΛΑΤΗ ΑΠΟ ΥΦΑΣΜΑ MESH ΓΙΑ ΤΗΝ ΚΑΛΗ ΚΥΚΛΟΦΟΡΙΑ ΤΟΥ ΑΕΡΑ ΙΔΑΝΙΚΗ ΓΙΑ ΠΟΛΥΩΡΗ ΕΡΓΑΣΙΑ

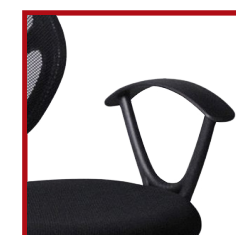

2

ΕΡΓΟΝΟΜΙΚΑ ΜΠΡΑΤΣΑ



3

ΜΗΧΑΝΙΣΜΟΣ ΓΙΑ ΚΑΘΥΨΟΣ ΡΥΘΜΙΣΗ ΕΔΡΑΣ



4

NYLON ΑΚΤΙΝΩΤΗ ΒΑΣΗ ΣΕ ΜΑΥΡΟ ΧΡΩΜΑ

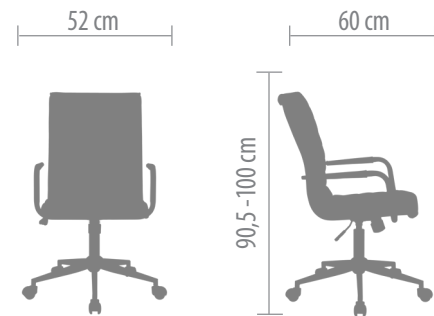

SENSO MODELS

BEIGE	25-0727
MENTA	25-0728
GREY	25-0729

SENSO CHARACTERISTICS & POTENTIALS

SENSO WHO IS WHO

ΥΛΙΚΟ:	FABRIC
ΜΗΧΑΝΙΣΜΟΣ:	LOCK TILT
ΒΑΣΗ:	ΜΕΤΑΛΛΙΚΗ
GAS LIFT:	120mm
ΤΡΟΧΟΙ:	50mm RUBBER
ΜΕΓΙΣΤΟ ΒΑΡΟΣ:	120kg



1

FABRIC



2 3

ΜΗΧΑΝΙΣΜΟΣ ΓΙΑ ΕΛΕΥΘΕΡΙΑ ΚΙΝΗΣΗΣ ΠΛΑΤΗΣ ΣΕ ΘΕΣΗ RELAX ΚΑΙ ΚΑΘΥΨΟΣ ΡΥΘΜΙΣΗ ΕΔΡΑΣ



4

ΜΕΤΑΛΛΙΚΗ ΑΚΤΙΝΩΤΗ ΒΑΣΗ ΣΕ ΜΑΥΡΟ ΧΡΩΜΑ





URBAN MODELS

WATER BLUE	25-0475
ΓΚΡΙ	25-0476

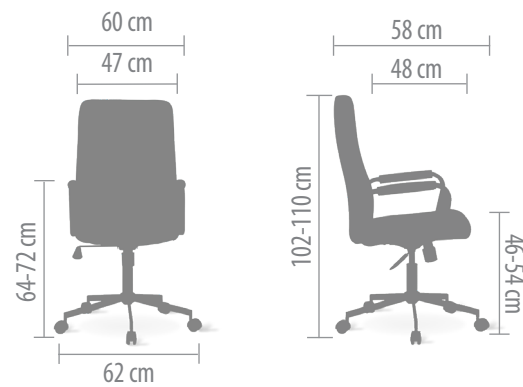

URBAN CHARACTERISTICS & POTENTIALS

URBAN WHO IS WHO

ΥΛΙΚΟ: ΒΕΛΟΥΔΟ  
 ΜΗΧΑΝΙΣΜΟΣ: LOCK TILT  
 ΒΑΣΗ: ΜΕΤΑΛΛΙΚΗ  
 GAS LIFT: 80mm  
 ΤΡΟΧΟΙ: 50mm RUBBER  
 ΜΕΓΙΣΤΟ ΒΑΡΟΣ: 90kg



1

ΕΠΕΝΔΥΜΕΝΑ ΜΠΡΑΤΣΑ



2

ΨΗΛΗ ΠΛΑΤΗ



3 4

ΜΗΧΑΝΙΣΜΟΣ ΓΙΑ  
 ΕΛΕΥΘΕΡΙΑ ΚΙΝΗΣΗΣ  
 ΠΛΑΤΗΣ ΣΕ ΘΕΣΗ RELAX ΚΑΙ  
 ΚΑΘΥΨΟΣ ΡΥΘΜΙΣΗ ΕΔΡΑΣ



5

ΜΕΤΑΛΛΙΚΗ ΑΚΤΙΝΩΤΗ  
 ΒΑΣΗ ΧΡΩΜΙΟΥ

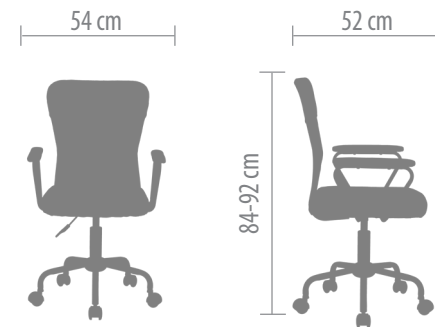

**BELL MODELS**

ΛΑΔΙ	25-0723
ΜΕΝΤΑ	25-0724
ΣΑΠΙΟ ΜΗΛΟ	25-0725
ΓΚΡΙ	25-0726

**BELL CHARACTERISTICS & POTENTIALS**

**BELL WHO IS WHO**

**ΥΛΙΚΟ:** ΥΦΑΣΜΑ & MESH  
**ΜΗΧΑΝΙΣΜΟΣ:** UP & DOWN  
**ΒΑΣΗ:** ΜΕΤΑΛΛΙΚΗ  
**GAS LIFT:** 120mm  
**ΤΡΟΧΟΙ:** 50mm RUBBER  
**ΜΕΓΙΣΤΟ ΒΑΡΟΣ:** 120kg



1

ΥΦΑΣΜΑ & MESH



2

ΕΡΓΟΝΟΜΙΚΗ ΠΛΑΤΗ



3

ΜΗΧΑΝΙΣΜΟΣ ΓΙΑ ΚΑΘΥΨΟΣ ΡΥΘΜΙΣΗ ΕΔΡΑΣ



4

NYLON ΑΚΤΙΝΩΤΗ ΒΑΣΗ ΣΕ ΜΑΥΡΟ & GUN ΧΡΩΜΑ

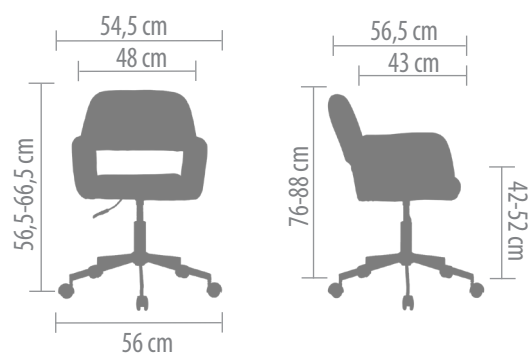

**IDOLS MODELS**

MAYPO	25-0483
GOLDFINGER	25-0464
DUSTY PINK	25-0465
ΠΡΑΣΣΙΝΟ	25-0466

**IDOLS CHARACTERISTICS & POTENTIALS**

**IDOLS WHO IS WHO**

**ΥΛΙΚΟ:** ΒΕΛΟΥΔΟ  
**ΜΗΧΑΝΙΣΜΟΣ:** UP & DOWN  
**ΒΑΣΗ:** ΜΕΤΑΛΛΙΚΗ  
**GAS LIFT:** 100mm  
**ΤΡΟΧΟΙ:** 50mm RUBBER  
**ΜΕΓΙΣΤΟ ΒΑΡΟΣ:** 100kg



1  
ΒΕΛΟΥΔΟ



2  
ΣΥΓΧΡΟΝΟ DESIGN



3  
ΜΗΧΑΝΙΣΜΟΣ ΓΙΑ ΚΑΘΥΨΟΣ  
ΡΥΘΜΙΣΗ ΕΔΡΑΣ



4  
ΜΕΤΑΛΛΙΚΗ ΑΚΤΙΝΩΤΗ  
ΒΑΣΗ ΧΡΩΜΙΟΥ



PEPPA MODELS

DUSTY PINK	25-0469
MENTA	25-0470
ΚΕΡΑΜΙΔΙ	25-0471

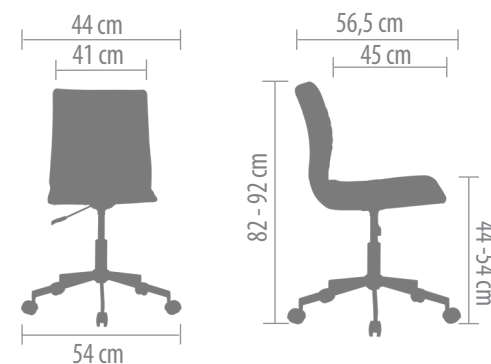

PEPPA CHARACTERISTICS & POTENTIALS

PEPPA WHO IS WHO

ΥΛΙΚΟ: ΒΕΛΟΥΔΟ  
 ΜΗΧΑΝΙΣΜΟΣ: UP & DOWN  
 ΒΑΣΗ: ΜΕΤΑΛΛΙΚΗ  
 GAS LIFT: 80mm  
 ΤΡΟΧΟΙ: 50mm RUBBER  
 ΜΕΓΙΣΤΟ ΒΑΡΟΣ: 90kg

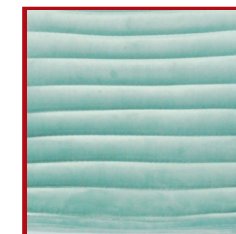

1  
ΒΕΛΟΥΔΟ



2  
ΕΡΓΟΝΟΜΙΚΗ ΠΛΑΤΗ



3  
ΜΗΧΑΝΙΣΜΟΣ ΓΙΑ ΚΑΘΥΨΟΣ ΡΥΘΜΙΣΗ ΕΔΡΑΣ



4  
ΜΕΤΑΛΛΙΚΗ ΑΚΤΙΝΩΤΗ ΒΑΣΗ ΧΡΩΜΙΟΥ

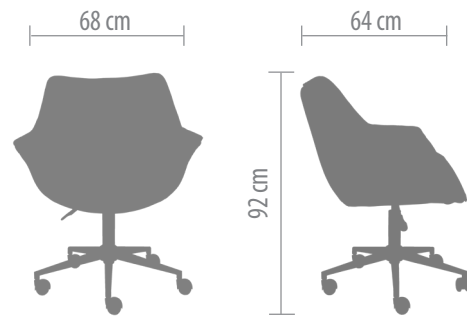

JONES MODELS

ΚΑΦΕ	25-0714
BEIGE	25-0715

JONES CHARACTERISTICS & POTENTIALS

JONES WHO IS WHO

ΥΛΙΚΟ: ΤΕΧΤΗΤΟ ΔΕΡΜΑ  
 ΜΗΧΑΝΙΣΜΟΣ: UP & DOWN  
 ΒΑΣΗ: ΜΕΤΑΛΛΙΚΗ  
 GAS LIFT: 80mm  
 ΤΡΟΧΟΙ: 50mm RUBBER  
 ΜΕΓΙΣΤΟ ΒΑΡΟΣ: 90kg



1

ΤΕΧΤΗΤΟ ΔΕΡΜΑ  
 ΥΨΗΛΗΣ ΠΟΙΟΤΗΤΑΣ PU



2

ΜΗΧΑΝΙΣΜΟΣ ΓΙΑ  
 ΚΑΘΥΨΟΣ ΡΥΘΜΙΣΗ ΕΔΡΑΣ



3

ΜΕΤΑΛΛΙΚΗ ΑΚΤΙΝΩΤΗ  
 ΒΑΣΗ ΧΡΩΜΙΟΥ

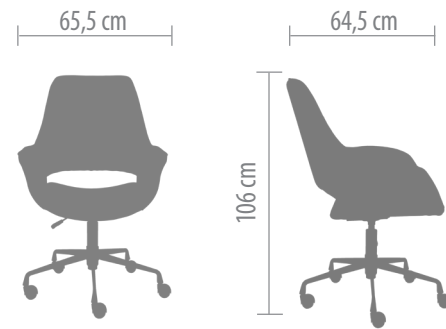

MINIMAL MODELS

ΚΑΦΕ	25-0716
ΜΑΥΡΟ	25-0717

MINIMAL CHARACTERISTICS & POTENTIALS

MINIMAL WHO IS WHO

ΥΛΙΚΟ: ΤΕΧΤΗΤΟ ΔΕΡΜΑ  
 ΜΗΧΑΝΙΣΜΟΣ: UP & DOWN  
 ΒΑΣΗ: ΜΕΤΑΛΛΙΚΗ



1

ΤΕΧΤΗΤΟ ΔΕΡΜΑ  
 ΥΨΗΛΗΣ ΠΟΙΟΤΗΤΑΣ PU



2

ΜΗΧΑΝΙΣΜΟΣ ΓΙΑ  
 ΚΑΘΥΨΟΣ ΡΥΘΜΙΣΗ ΕΔΡΑΣ



3

ΜΕΤΑΛΛΙΚΗ ΑΚΤΙΝΩΤΗ  
 ΒΑΣΗ ΧΡΩΜΙΟΥ

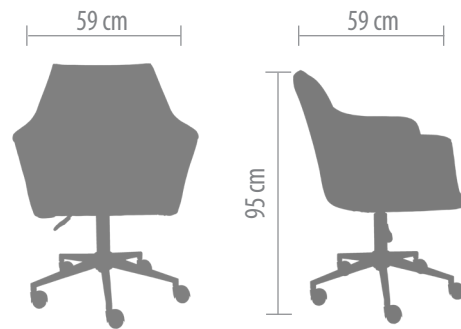

SELLE MODELS

CREAM	25-0718
ΜΑΥΡΟ	25-0719
ΜΠΛΕ	25-0720
TABAC	25-0721

SELLE WHO IS WHO

ΥΛΙΚΟ: ΤΕΧΤΗΤΟ ΔΕΡΜΑ  
 ΜΗΧΑΝΙΣΜΟΣ: UP & DOWN  
 ΒΑΣΗ: ΜΕΤΑΛΛΙΚΗ



1

ΤΕΧΤΗΤΟ ΔΕΡΜΑ  
 ΥΨΗΛΗΣ ΠΟΙΟΤΗΤΑΣ PU



2

ΜΗΧΑΝΙΣΜΟΣ ΓΙΑ  
 ΚΑΘΥΨΟΣ ΡΥΘΜΙΣΗ ΕΔΡΑΣ



3

ΜΕΤΑΛΛΙΚΗ ΑΚΤΙΝΩΤΗ  
 ΒΑΣΗ ΧΡΩΜΙΟΥ

SELLE CHARACTERISTICS & POTENTIALS

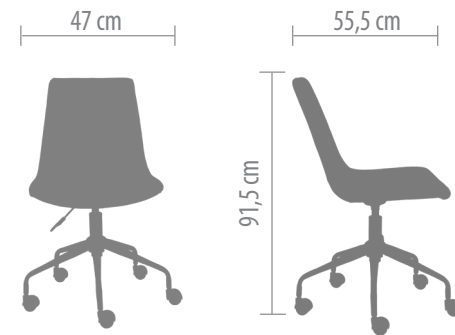

VINTAGE MODELS

TABAC

25-0722

VINTAGE CHARACTERISTICS & POTENTIALS

VINTAGE WHO IS WHO

ΥΛΙΚΟ: ΤΕΧΤΗΤΟ ΔΕΡΜΑ  
 ΜΗΧΑΝΙΣΜΟΣ: UP & DOWN  
 ΒΑΣΗ: ΜΕΤΑΛΛΙΚΗ



1

ΤΕΧΤΗΤΟ ΔΕΡΜΑ  
 ΥΨΗΛΗΣ ΠΟΙΟΤΗΤΑΣ PU



2

ΜΗΧΑΝΙΣΜΟΣ ΓΙΑ  
 ΚΑΘΥΨΟΣ ΡΥΘΜΙΣΗ ΕΔΡΑΣ



3

ΜΕΤΑΛΛΙΚΗ ΑΚΤΙΝΩΤΗ  
 ΒΑΣΗ ΧΡΩΜΙΟΥ



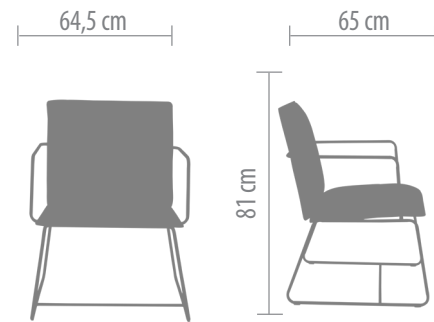

STANDBY MODELS

ΚΑΦΕ

01-3390

STANDBY WHO IS WHO

ΥΛΙΚΟ: ΥΦΑΣΜΑ SUEDE  
ΣΚΕΛΕΤΟΣ: ΜΕΤΑΛΛΙΚΟΣ  
ΜΕΓΙΣΤΟ ΒΑΡΟΣ: 120kg



1

ΥΦΑΣΜΑ SUEDE



2

ΜΕΤΑΛΛΙΚΟΣ ΣΚΕΛΕΤΟΣ  
ΣΕ GUN ΧΡΩΜΑ

STANDBY CHARACTERISTICS & POTENTIALS

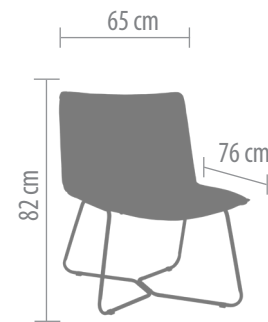

ATTENDRE MODELS

ΜΑΥΡΟ	25-0712
ΚΑΦΕ	25-0713

ATTENDRE CHARACTERISTICS & POTENTIALS

ATTENDRE WHO IS WHO

ΥΛΙΚΟ: ΤΕΧΤΗΤΟ ΔΕΡΜΑ  
 ΣΚΕΛΕΤΟΣ: ΜΕΤΑΛΛΙΚΟΣ



1

ΤΕΧΤΗΤΟ ΔΕΡΜΑ  
 ΥΨΗΛΗΣ ΠΟΙΟΤΗΤΑΣ PU

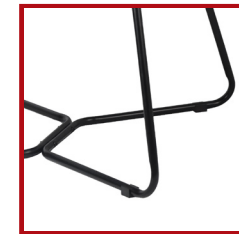

2

ΜΕΤΑΛΛΙΚΟΣ ΣΚΕΛΕΤΟΣ ΣΕ  
 ΜΑΥΡΟ ΧΡΩΜΑ



ΥΛΙΚΟ: ΥΦΑΣΜΑ  
 ΜΗΧΑΝΙΣΜΟΣ: UP & DOWN  
 ΒΑΣΗ: ΜΕΤΑΛΛΙΚΗ

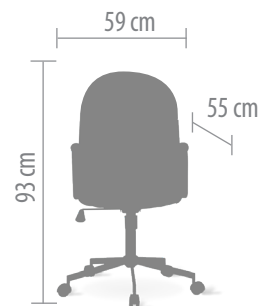

ΥΛΙΚΟ: ΥΦΑΣΜΑ  
 ΜΗΧΑΝΙΣΜΟΣ: UP & DOWN  
 ΒΑΣΗ: ΜΕΤΑΛΛΙΚΗ

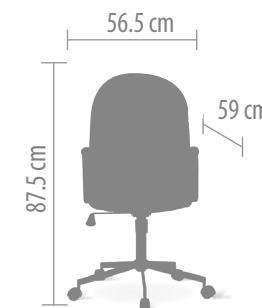

POST MODELS

- |              |         |
|--------------|---------|
| BEIGE - ΚΑΦΕ | 25-0738 |
| ΓΚΡΙ - ΜΑΥΡΟ | 25-0739 |
| ΛΑΔΙ - ΜΑΥΡΟ | 25-0740 |



LA LUNA MODELS

- |            |         |
|------------|---------|
| TERRACOTTA | 25-0742 |
| ΓΚΡΙ       | 25-0743 |
| ΜΟΥΣΤΑΡΔΙ  | 25-0744 |





Με την επιφύλαξη ενδεχόμενων τυπογραφικών λαθών ή σφαλμάτων.

Created by Marketing & Communication dept. Liberta

© Copyright - All rights reserved Liberta