

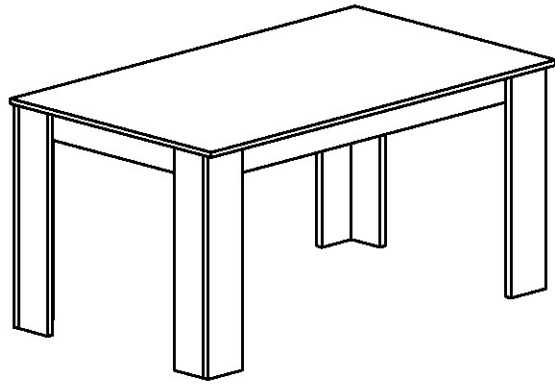







2 ΧΡΟΝΙΑ ΕΓΓΥΗΣΗ

A	1370x850	1//1
B	2x 1310x100	1//1
C	2x 754x100	1//1
D	754x100	1//1
E	2x 732x120	1//1
F	2x 732x102	1//1
G	2x 732x120	1//1
H	2x 732x102	1//1



26x  10015	36x  10013	26x  50317	8x  50738	16x  10093	16x  M 6x30 10025	16x  Φ 3.5/20 10002
---	---	---	--	---	---	---

