

ASSEMBLY INSTRUCTION

032055

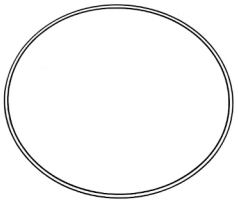

A

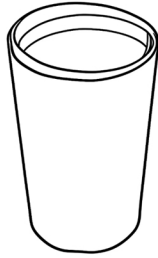

B

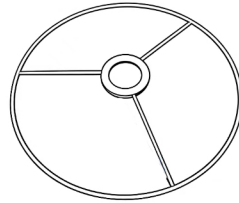

C



D

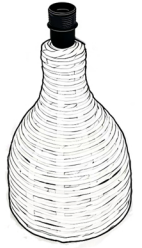

E

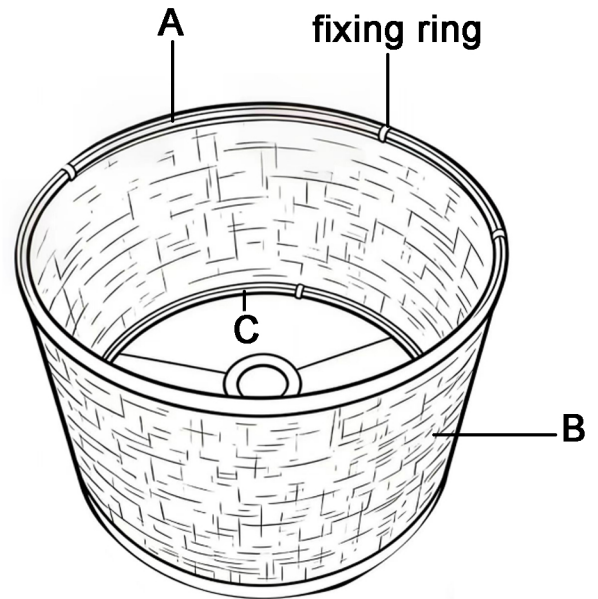
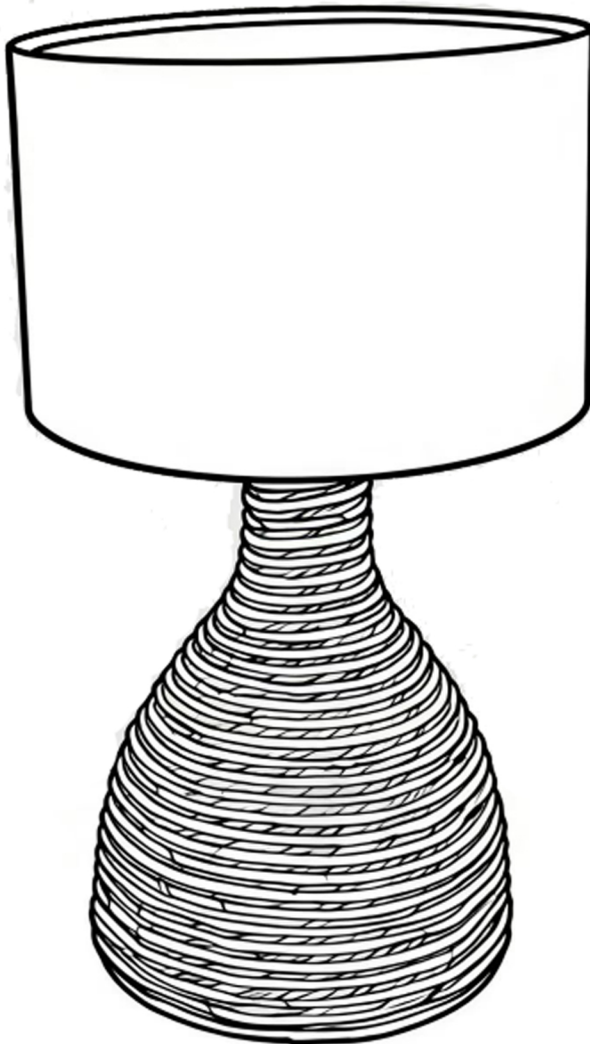

Step 1: Fix A onto B, which has 5 fixing rings

Step 2: Fix C onto B, which has 5 fixing rings

Step 3: Bond the two sides of B together

Step 4: Place ABC on E and rotate clockwise with D to secure

ΣΧΕΔΙΟ ΣΥΝΑΡΜΟΛΟΓΗΣΗΣ

032055

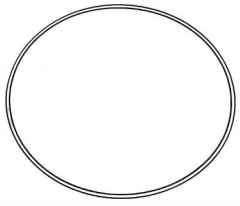

A

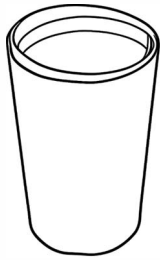

B

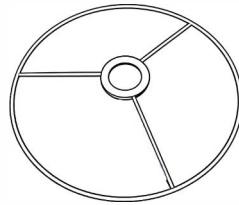

C



D



E

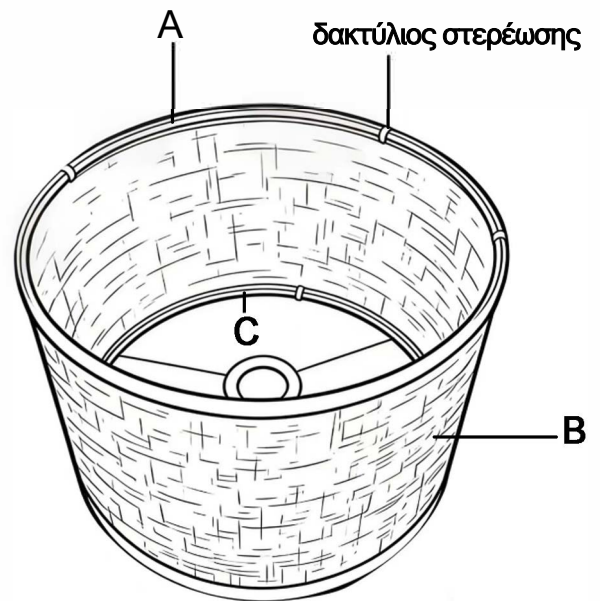
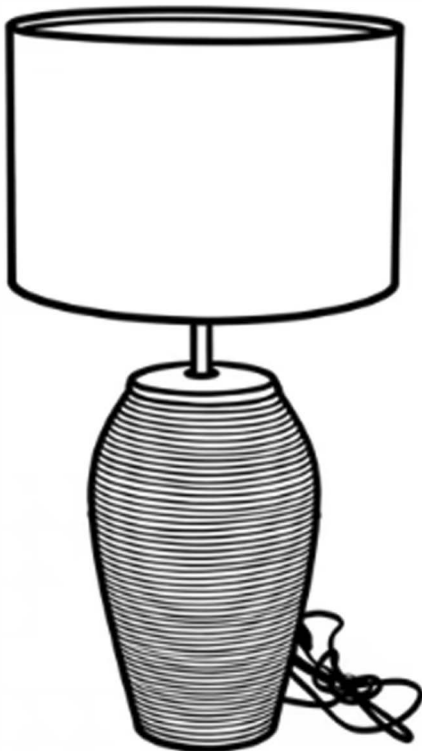

Βήμα 1: Στερεώστε το A πάνω στο B, το οποίο έχει 5 δακτυλίους στερέωσης

Βήμα 2: Στερεώστε το C πάνω στο B, το οποίο έχει 5 δακτυλίους στερέωσης

Βήμα 3: Ενώστε τις δύο πλευρές του B μεταξύ τους

Βήμα 4: Τοποθετήστε το ABC πάνω στο E και περιστρέψτε δεξιόστροφα με το D για να ασφαλίσει.