

1

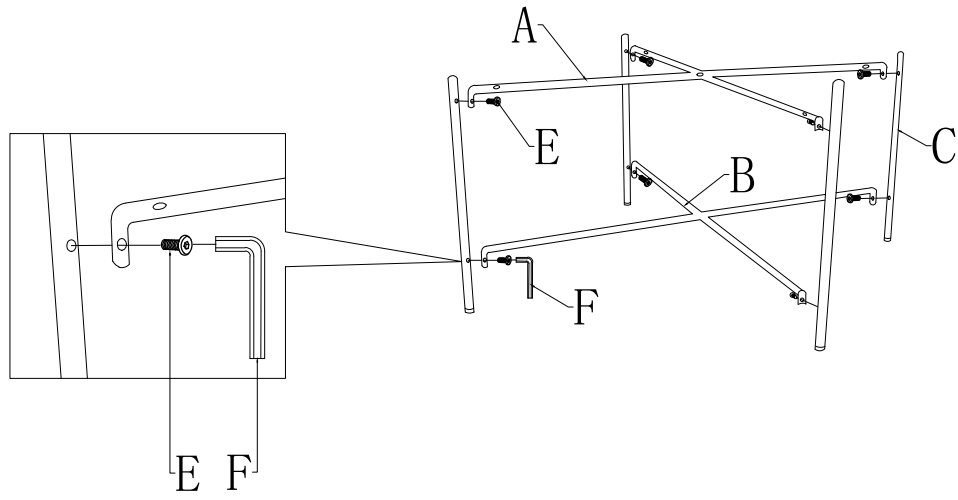

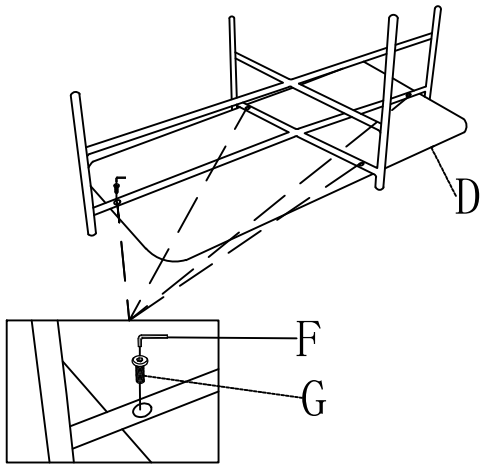



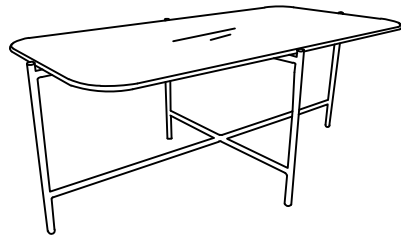

2

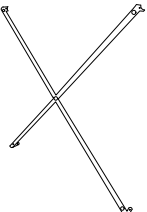
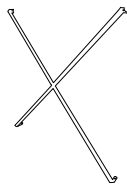

3



A×1	B×1	C×4	D×1	E×8	F×1	G×4
				 M6×10		 M6×20