

**2 ΧΡΟΝΙΑ ΕΓΓΥΗΣΗ**

A	1530x380	1/3
B	1530x380	1/3
C	793x380	2/3
D	793x380	2/3
E	793x376	2/3
F	793x376	2/3
G	2x 486x360	2/3
H	8x 350x120	2/3
I	4x 437x120	1/3
J	1530x80	1/3
K	4x 507x184	1/3
L	2x 507x742	3/3
M	4x 466x356	3/3
N	6x 406x506	3/3
O	2x 485x15	3/3
P	493x15	3/3

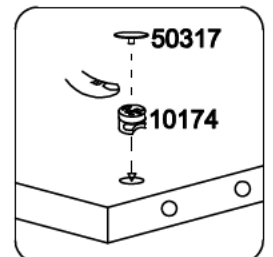

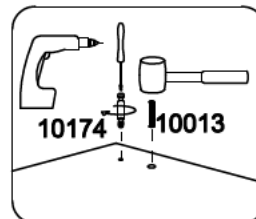
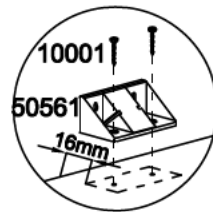
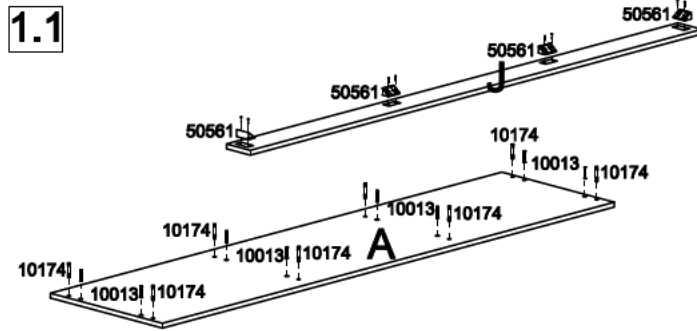
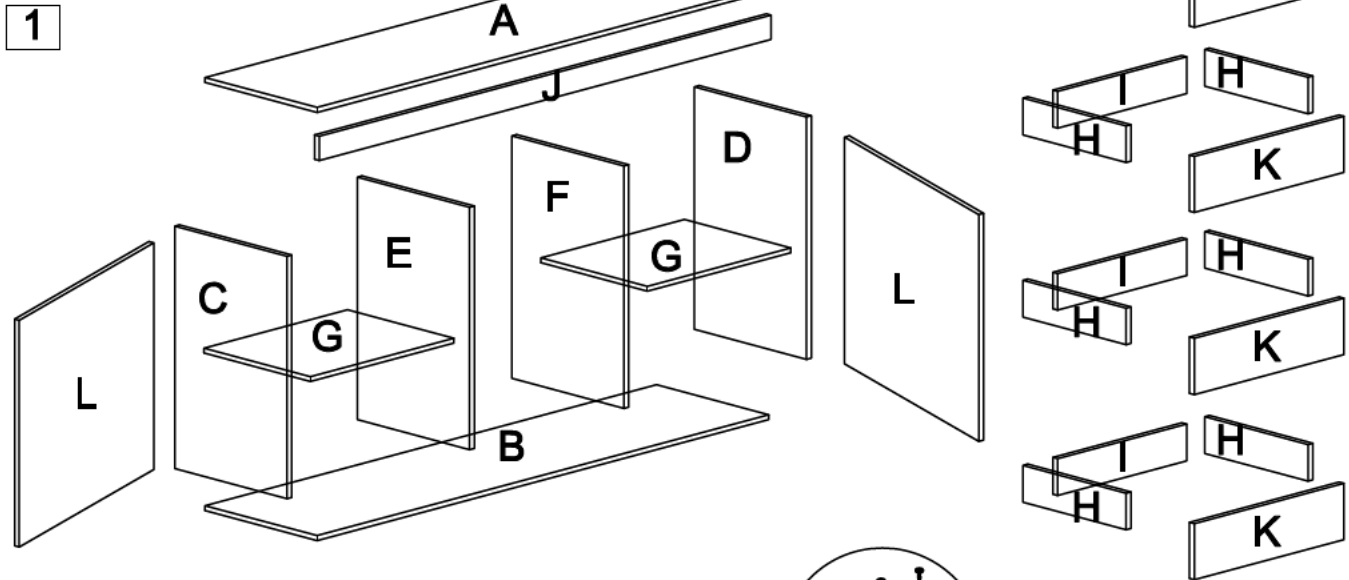
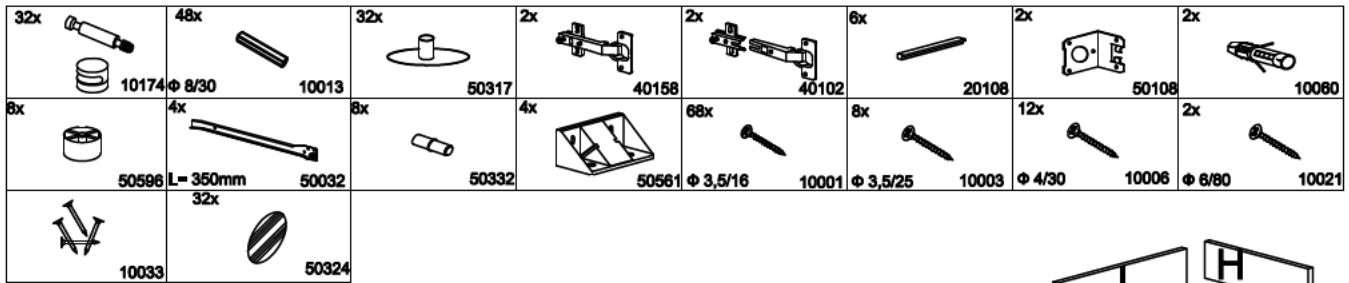
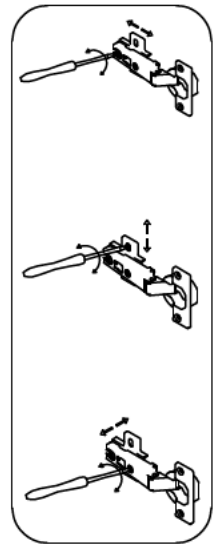
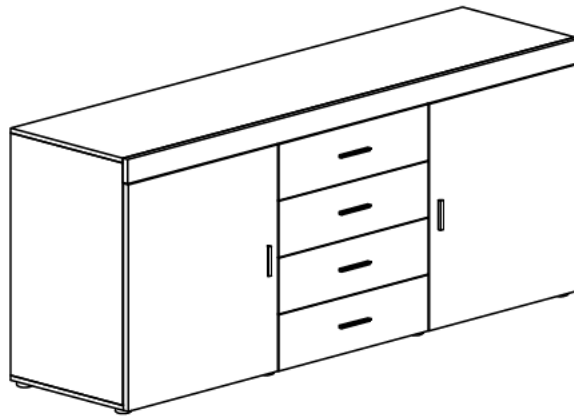
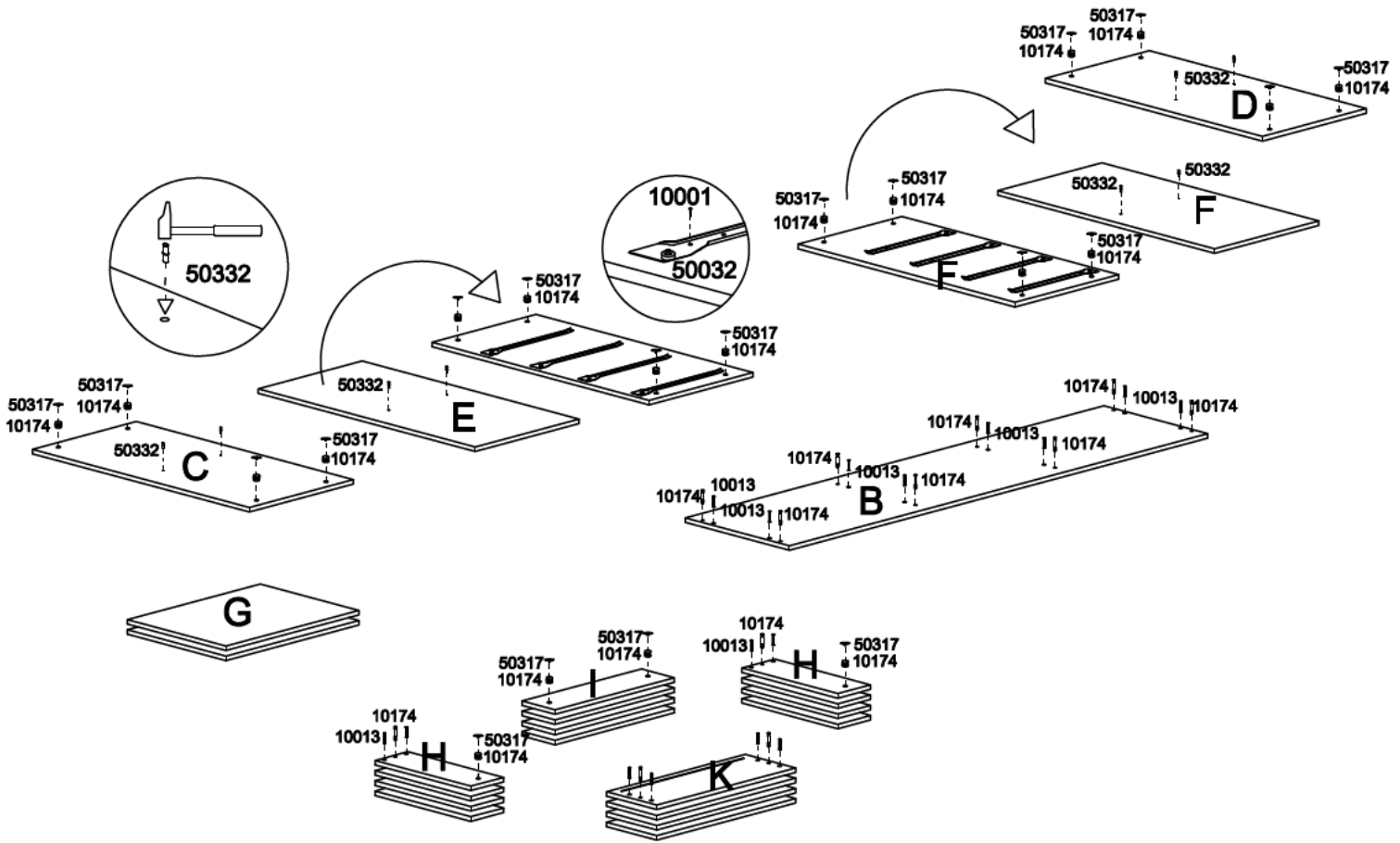

1.2

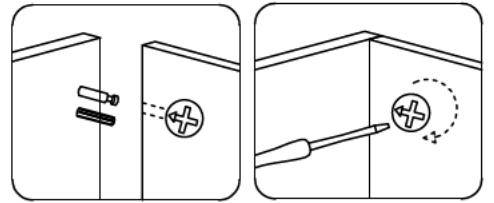
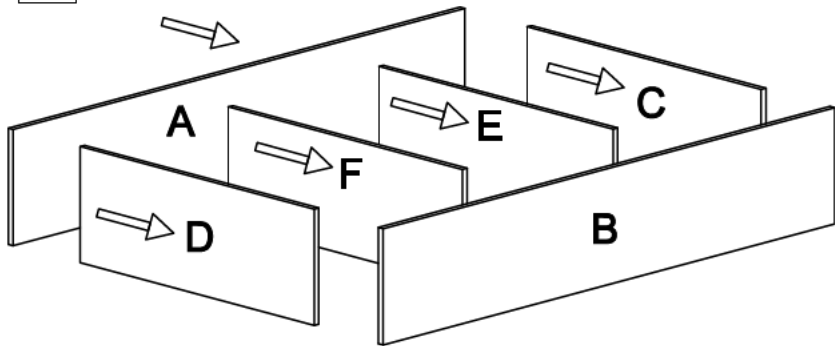

1.3

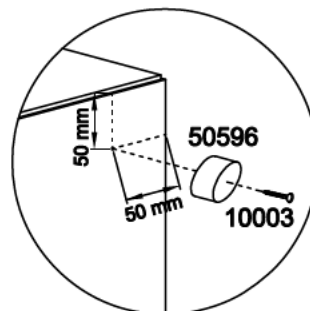
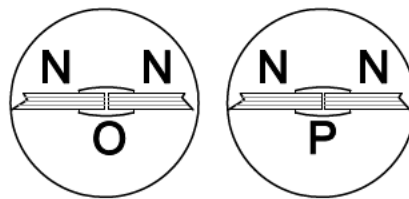
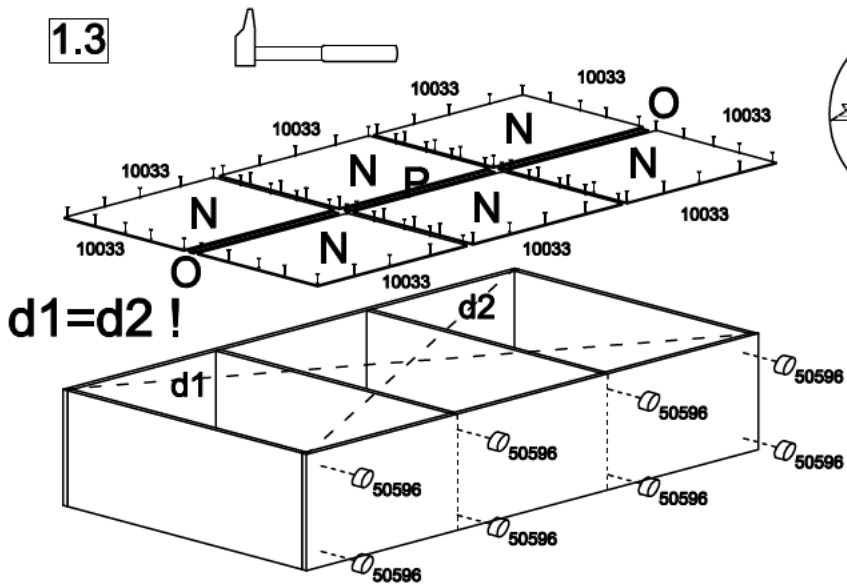

1.4

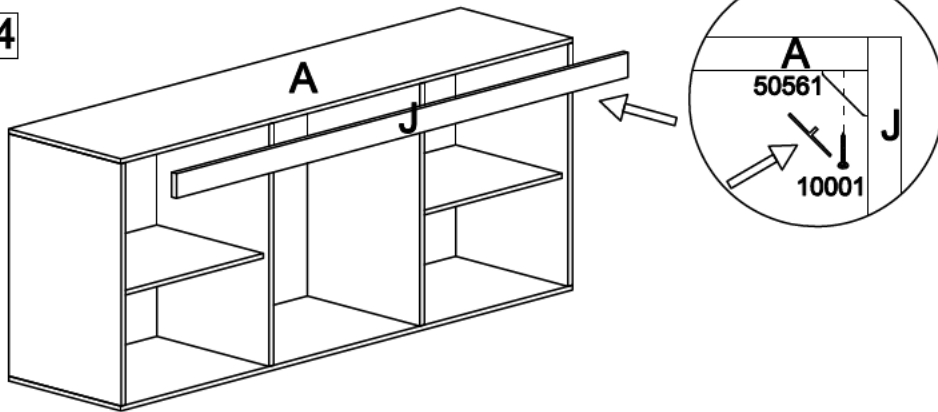

1.5

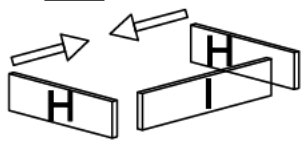

1.6

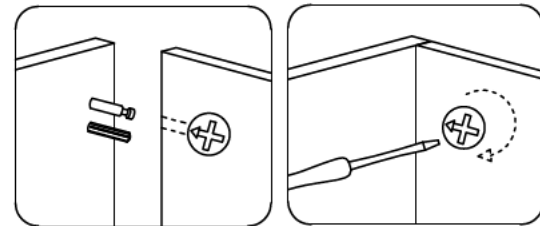
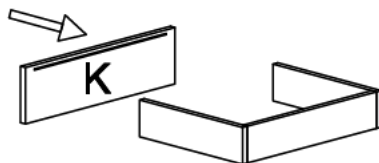

1.7

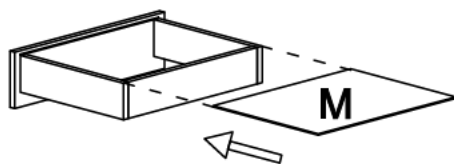

1.8



d1=d2 !

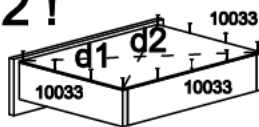

1.9

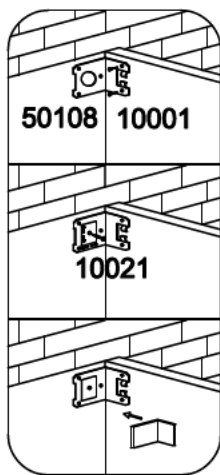
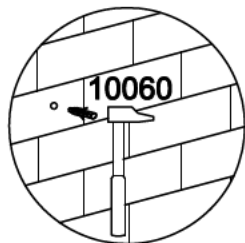
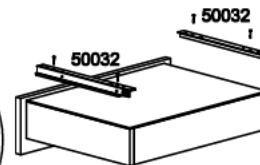
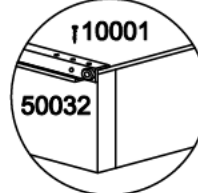

ΑΠΑΡΑΙΤΗΤΗ Η ΣΤΗΡΙΞΗ ΣΤΟΝ ΤΟΙΧΟ

