

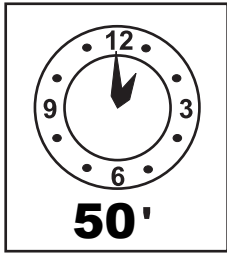

2

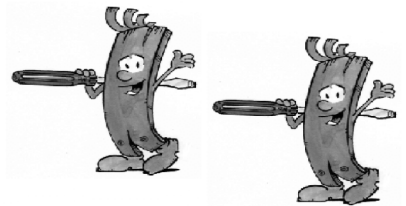

50'

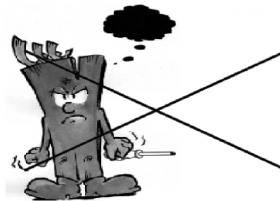
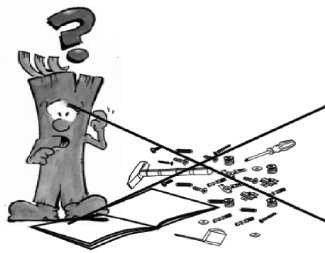
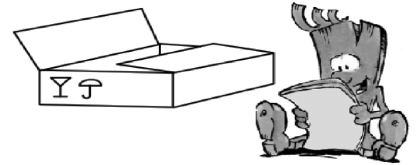
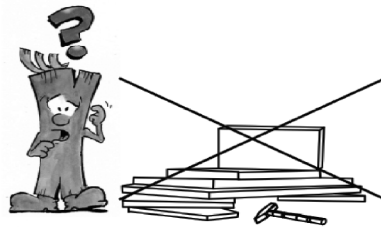
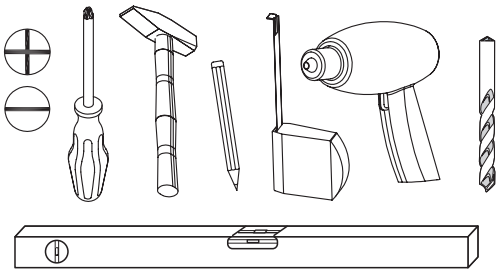

ΑΠΑΡΑΙΤΗΤΗ Η ΣΤΗΡΙΞΗ ΣΤΟΝ ΤΟΙΧΟ

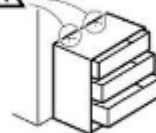

2 ΧΡΟΝΙΑ ΕΓΓΥΗΣΗ



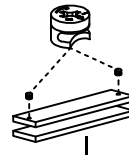
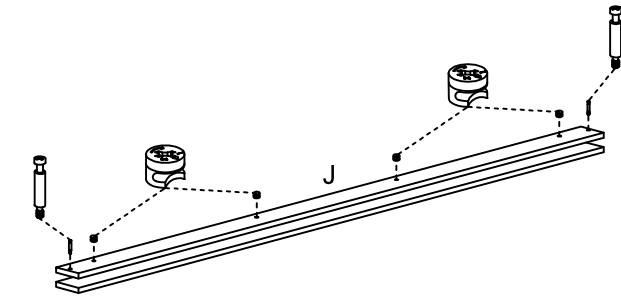
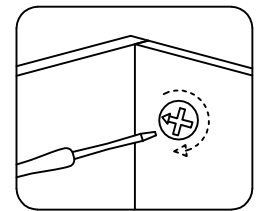
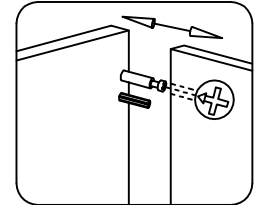
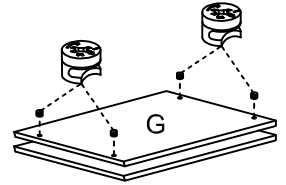
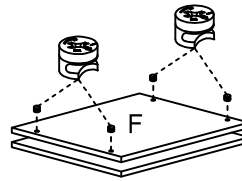
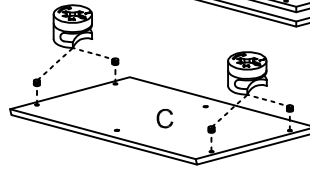
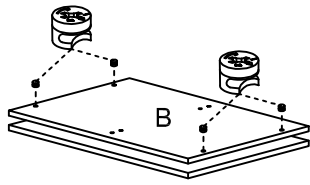
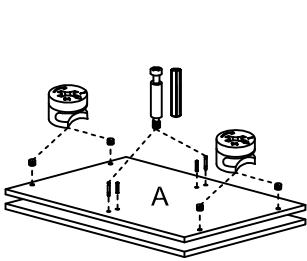
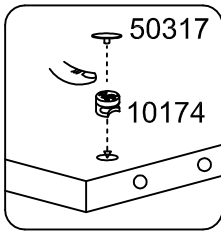
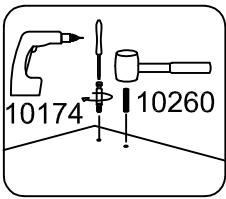

1.2

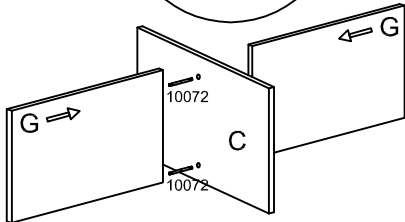
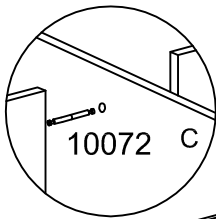

1.3

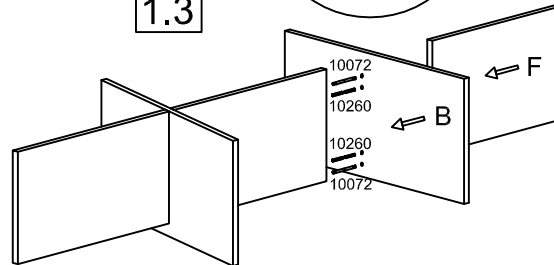
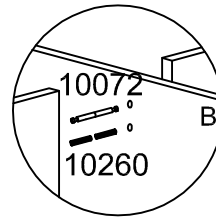

1.4

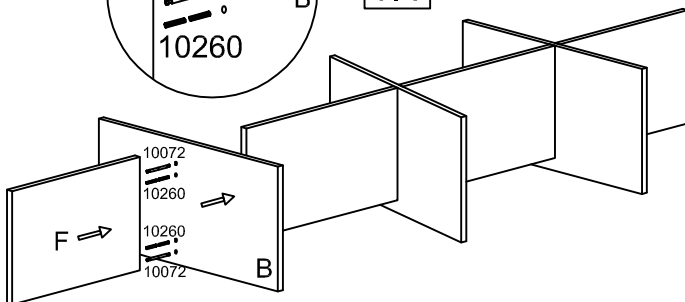
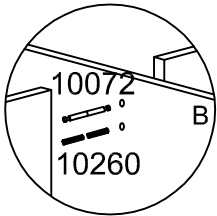

1.5

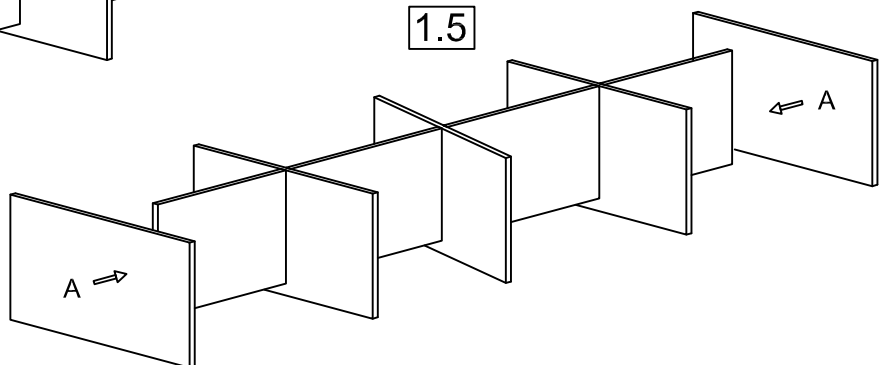

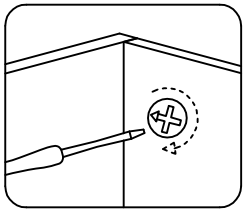
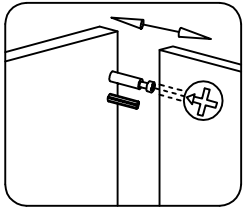

1.6

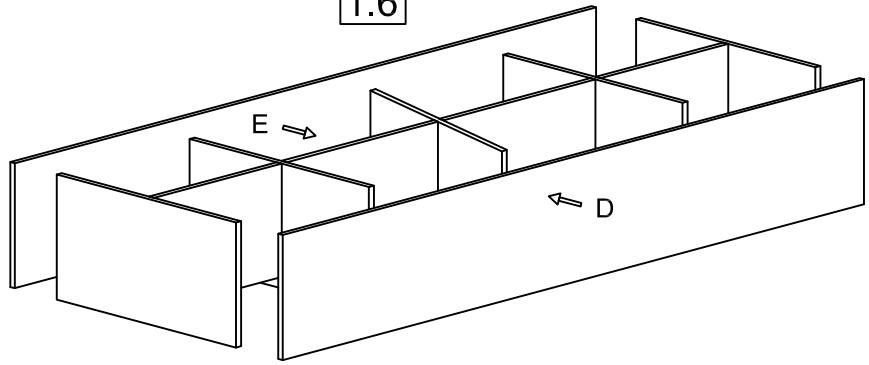

1.7

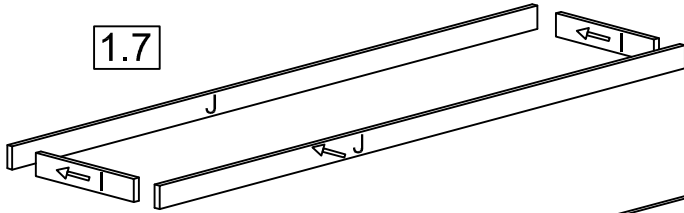

1.8

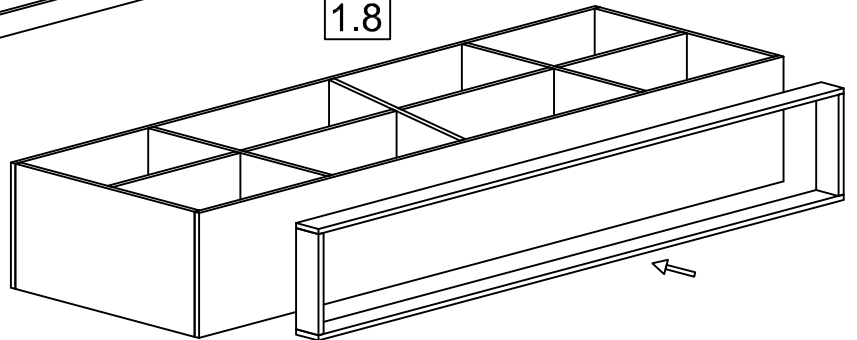

1.9

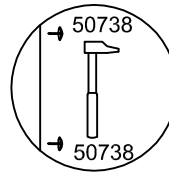
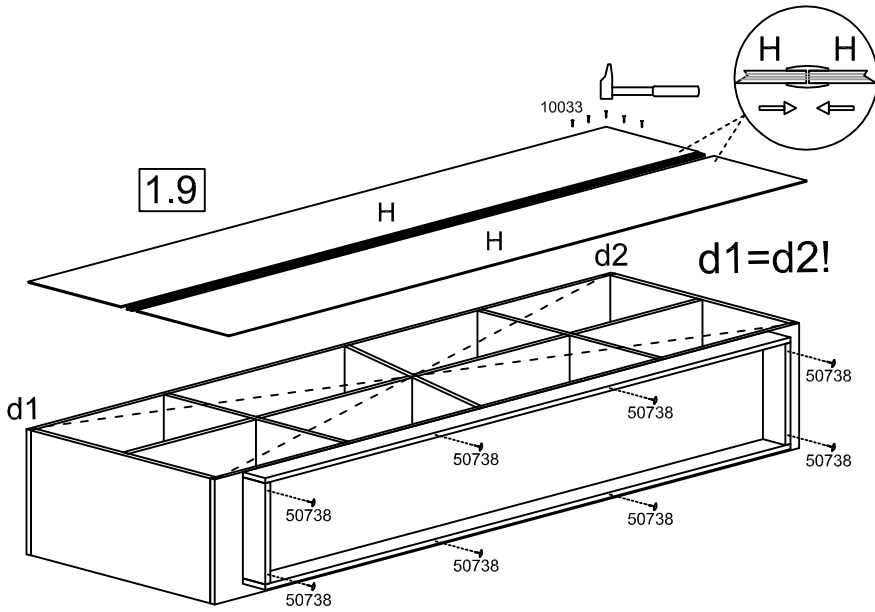

1.10

