













- 
**ALYAN STOPPER**  
 24 PCS 24 ΡΟΔΕΛΕΣ  
 ΑΛΕΝ
- 
**ALYAN SCREW**  
 6 PCS 6 ΒΙΔΕΣ ΑΛΕΝ
- 
**ALYAN**  
 1 PCS 1 ΑΛΕΝ
- 
**HANDLE**  
 2 PCS 2 ΧΕΡΟΥΛΙΑ
- 
**EXTERIOR COVER HINGE**  
 2 PCS 2 ΜΕΝΤΕΣΕΛΕΣ  
 ΓΙΑ ΤΙΣ ΠΟΡΤΕΣ
- 
**HANGER FLANGE**  
 6 PCS 6 ΣΤΗΡΙΓΜΑΤΑ ΓΙΑ  
 ΡΑΒΔΟΥΣ
- 
**WEDGE 20\*30**  
 6 PCS 6 ΠΑΤΟΥΣΑΚΙΑ
- 
**MINIFIX SHAFT**  
 24 PCS 24 ΒΙΔΕΣ  
 MINIFIX
- 
**MINIFIX HEAD**  
 24 PCS 24 MINIFIX  
 ΚΕΦΑΛΕΣ
- 
**SHELF PIN**  
 10 PCS 10 ΣΤΗΡΙΓΜΑΤΑ  
 ΡΑΦΙΩΝ
- 
**DOWEL**  
 8 PCS 8 ΣΥΝΔΕΤΙΚΑ  
 ΚΑΡΦΙΑ
- 
**NAIL**  
 50 PCS 50 ΚΑΡΦΙΑ
- 
**3,5\*18 SCREW**  
 36 PCS 36 ΒΙΔΕΣ



ΣΥΝΑΡΜΟΛΟΓΗΣΤΕ ΤΟ ΠΡΟΙΟΝ ΕΧΟΝΤΑΣ ΤΟ ΤΟΠΟΘΕΤΗΣΕΙ ΣΤΟ ΔΑΠΕΔΟ.



STRICTLY INSTALL THE PRODUCT BY PLATING IT ON THE FLOOR.

## 1. STEP

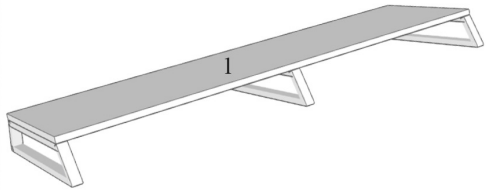

Screw the feet to the bottom plate.

Βιδώστε τα πόδια με το πάκел της βάσης.



## 2. STEP

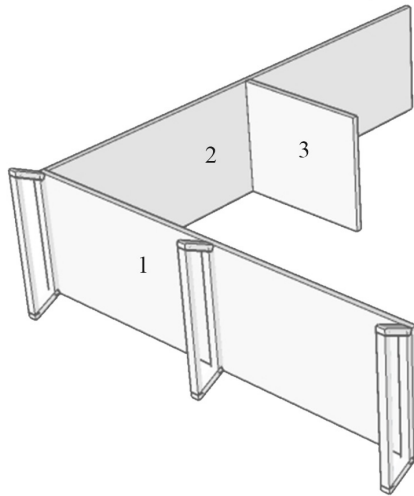

Mount the bottom plate and the fixed shelves with the help of allen screws.

Βιδώστε το πάκел της βάσης και τα σταθερά ράφια με τη χρήση άλεν.



## 3. STEP

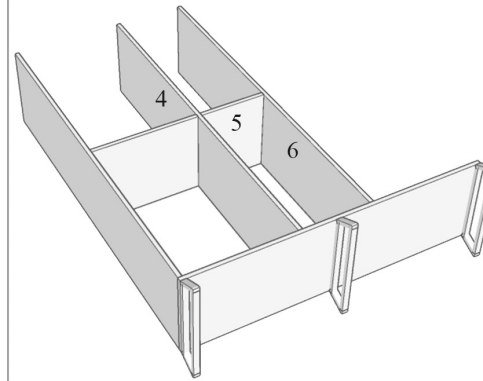

Assemble the center upright and the fixed shelf.

Τοποθετήστε τα κεντρικά πάκел σε όρθια θέση όπως και το σταθερό ράφι όπως φαίνεται στην φωτογραφία.



## 4. STEP

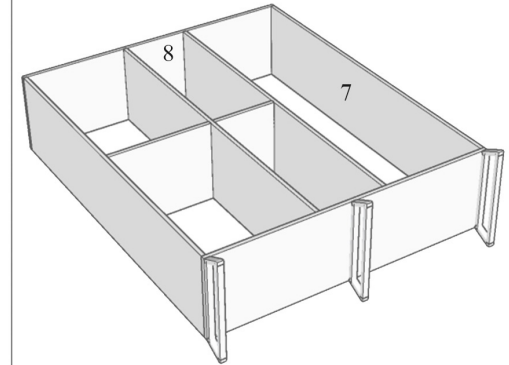

Assemble the side plate and the top plate.

Συνδέστε το πλαϊνό πάκел με το άνω πάκел.



## 5. STEP

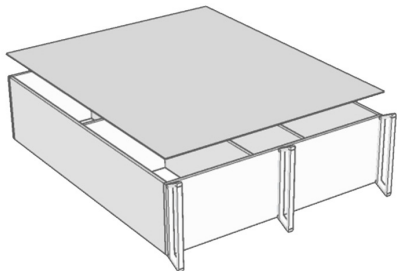

Hammer the back.  
Καρφώστε την πλάτη.



## 6. STEP

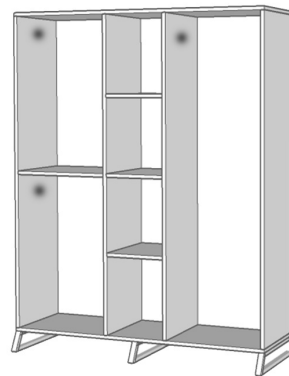

Placed the hanger flanges and movable shelves.  
Τοποθετήστε τις βάσεις για τις μεταλλικές ράβδους και τα μετακινούμενα ράφια.



## 7. STEP

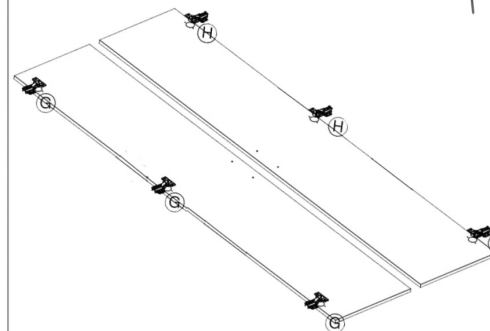

Let's mount the hinges on the doors first.  
Τοποθετήστε τους μεντεσέδες στις πόρτες.

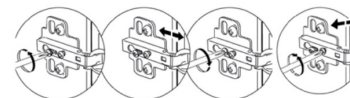

## 8. STEP

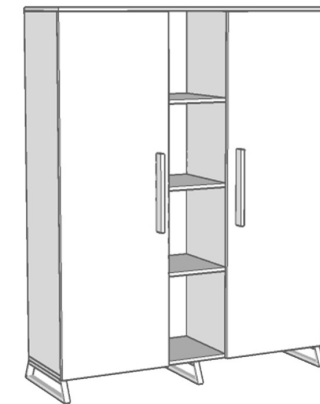

Finally, put on the covers.  
Τοποθετήστε τις πόρτες στη ντουλάπα.