

**2 ΧΡΟΝΙΑ ΕΓΓΥΗΣΗ**

A	518x360	1/1
B	518x360	1/1
C	2x 445x360	1/1
D	413x356	1/1
E	2x 269x433	1/1
F	339x407	1/1

Max. 10 kg.

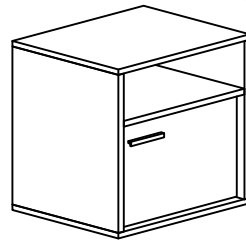

12x  10174	12x  10260	12x  50317	2x  40160	4x  50246	1x  20281	1x  50332	8x  Φ 3,5/16 10001
8x  Φ 3,5/20 10002	2x  Φ 4/30 10006	 10033					

1

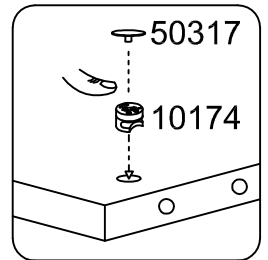
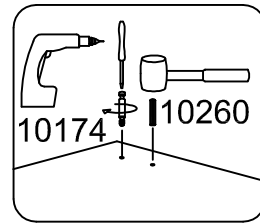
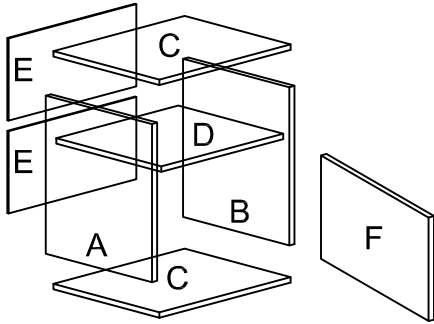

1.1

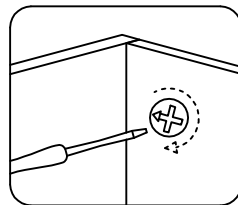
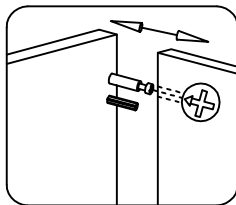
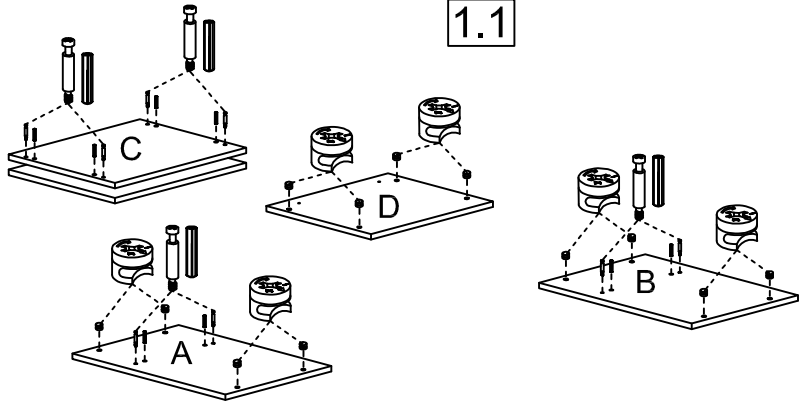

1.2

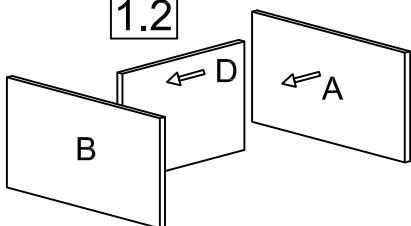

1.3

