

2 ΧΡΟΝΙΑ ΕΓΓΥΗΣΗ

A	518x360	1/1
B	518x360	1/1
C	2x 445x360	1/1
D	413x356	1/1
E	2x 269x433	1/1
F	339x407	1/1

Max. 10 kg.

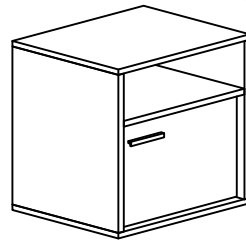

12x 10174	12x 10260	12x 50317	2x 40160	4x 50246	1x 20281	1x 50332	8x Φ 3,5/16 10001
8x Φ 3,5/20 10002	2x Φ 4/30 10006	 10033					

1

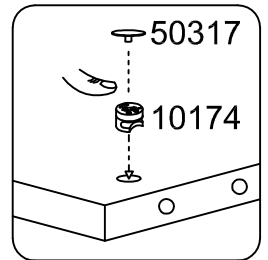
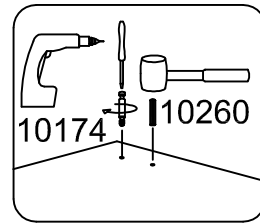
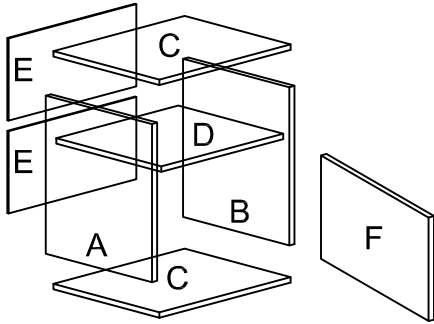

1.1

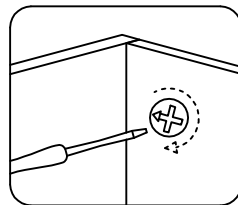
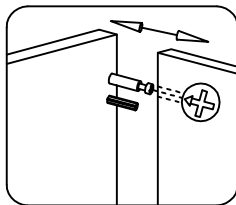
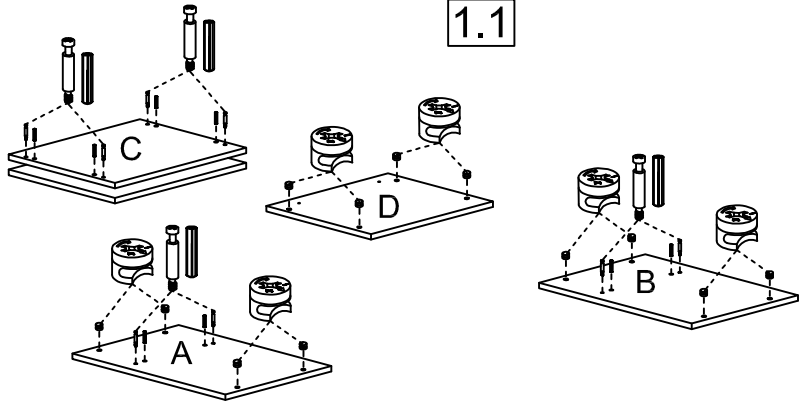

1.2

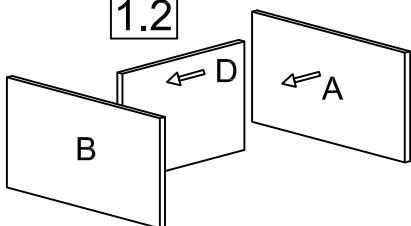

1.3

