

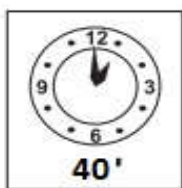

1

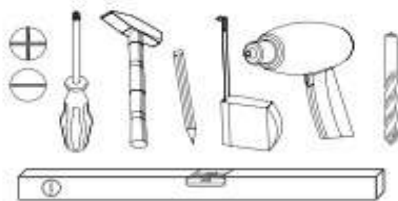

40'



2 ΧΡΟΝΙΑ ΕΓΓΥΗΣΗ

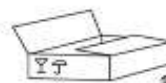

ΑΠΑΡΑΙΤΗΤΗ Η ΣΤΗΡΙΞΗ ΣΤΟΝ ΤΟΙΧΟ



A	1860x250	1/1
B	1860x250	1/1
C	1860x250	1/1
D	1860x250	1/1
E	18x299x250	1/1
F	3x299x230	1/1

42x 10174 	84x 10013 	42x 50317 	8x 50709
2x 30x30 50421 	2x 6x50 10060 	2x 4x50 10009 	4x 3,5x16 10001

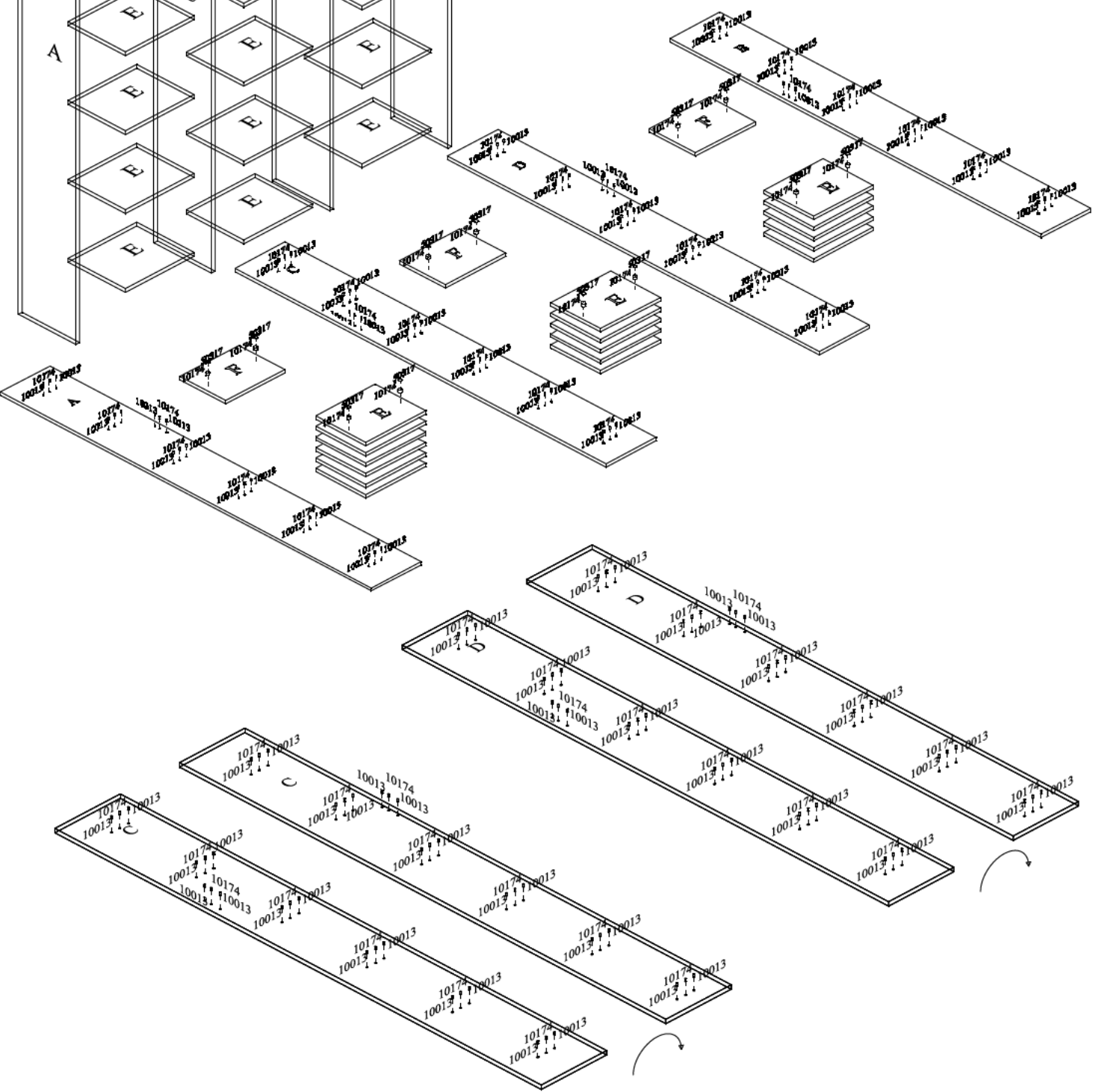
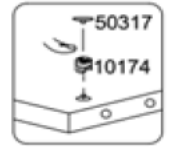
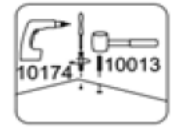
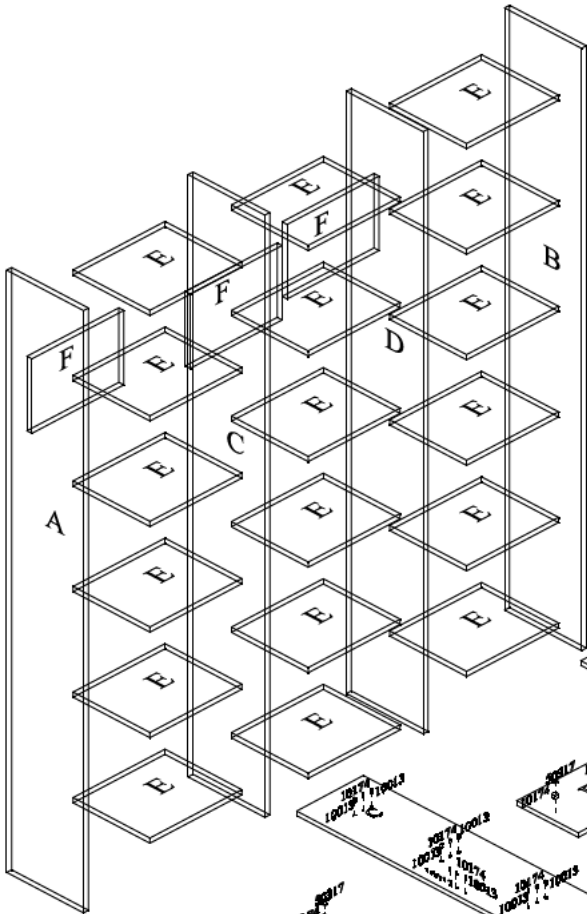

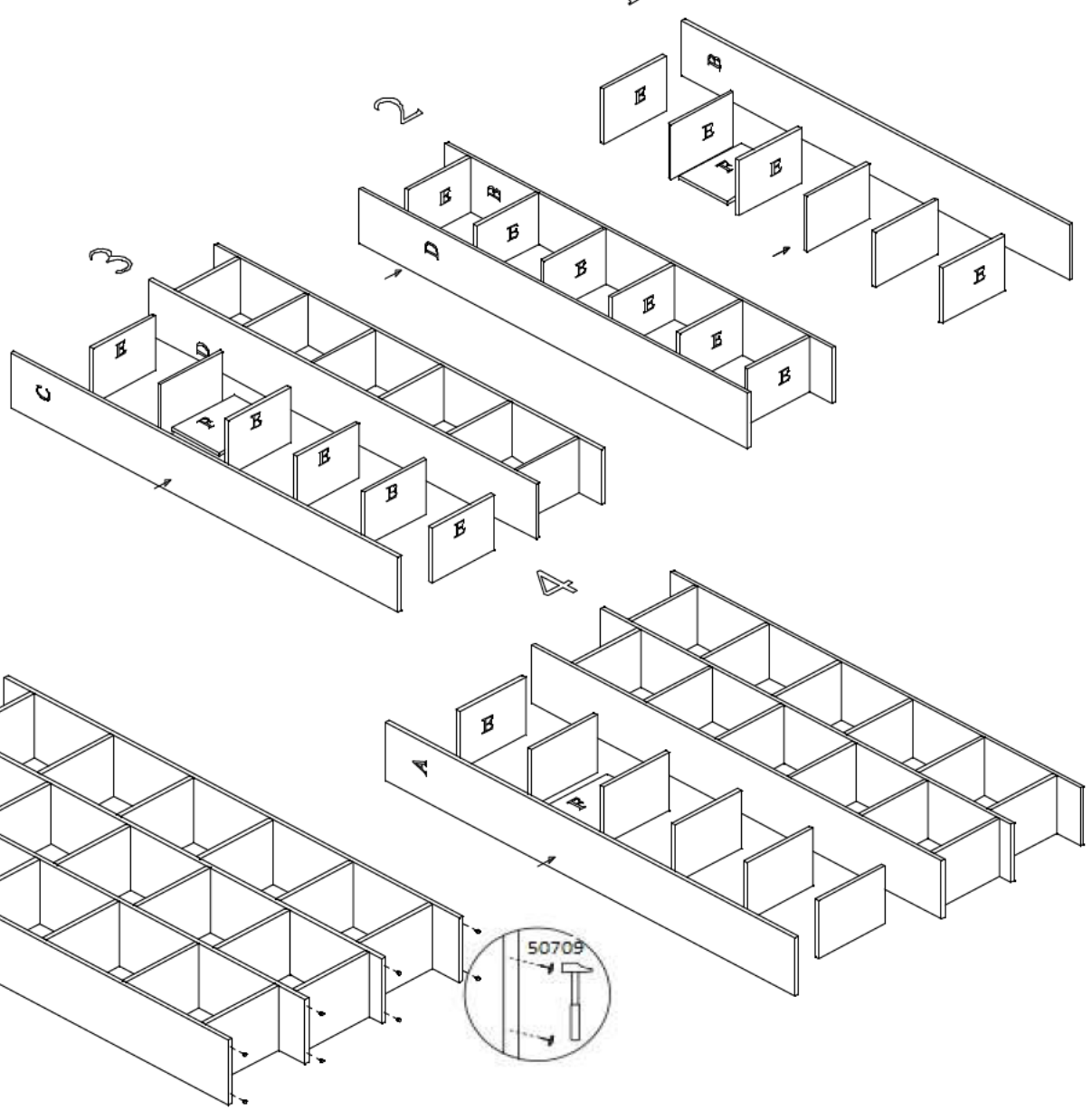
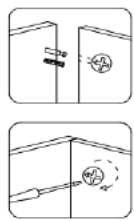

ΑΠΑΡΑΙΤΗΤΗ Η ΣΤΗΡΙΞΗ ΣΤΟΝ ΤΟΙΧΟ

