

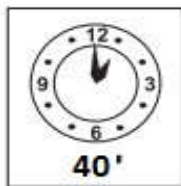

1

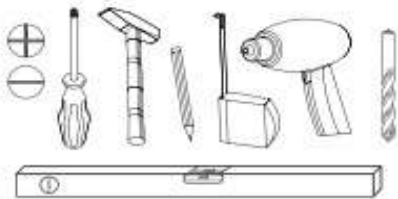

40'





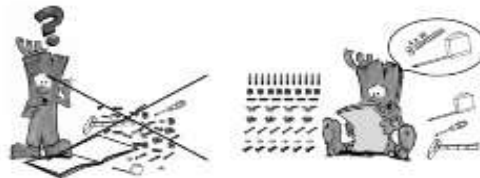
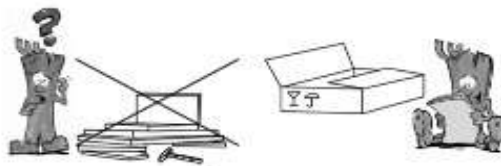





2 ΧΡΟΝΙΑ ΕΓΓΥΗΣΗ



ΑΠΑΡΑΙΤΗΤΗ Η ΣΤΗΡΙΞΗ ΣΤΟΝ ΤΟΙΧΟ



A	1860x250	1/1
B	1860x250	1/1
C	1860x250	1/1
D	1860x250	1/1
E	18x299x250	1/1
F	3x299x230	1/1

42x 	84x 	42x 	8x 
10174	10013	50317	50709
2x 	2x 	2x 	4x 
30x30 50421	6x50 10060	4x50 10009	3,5x16 10001

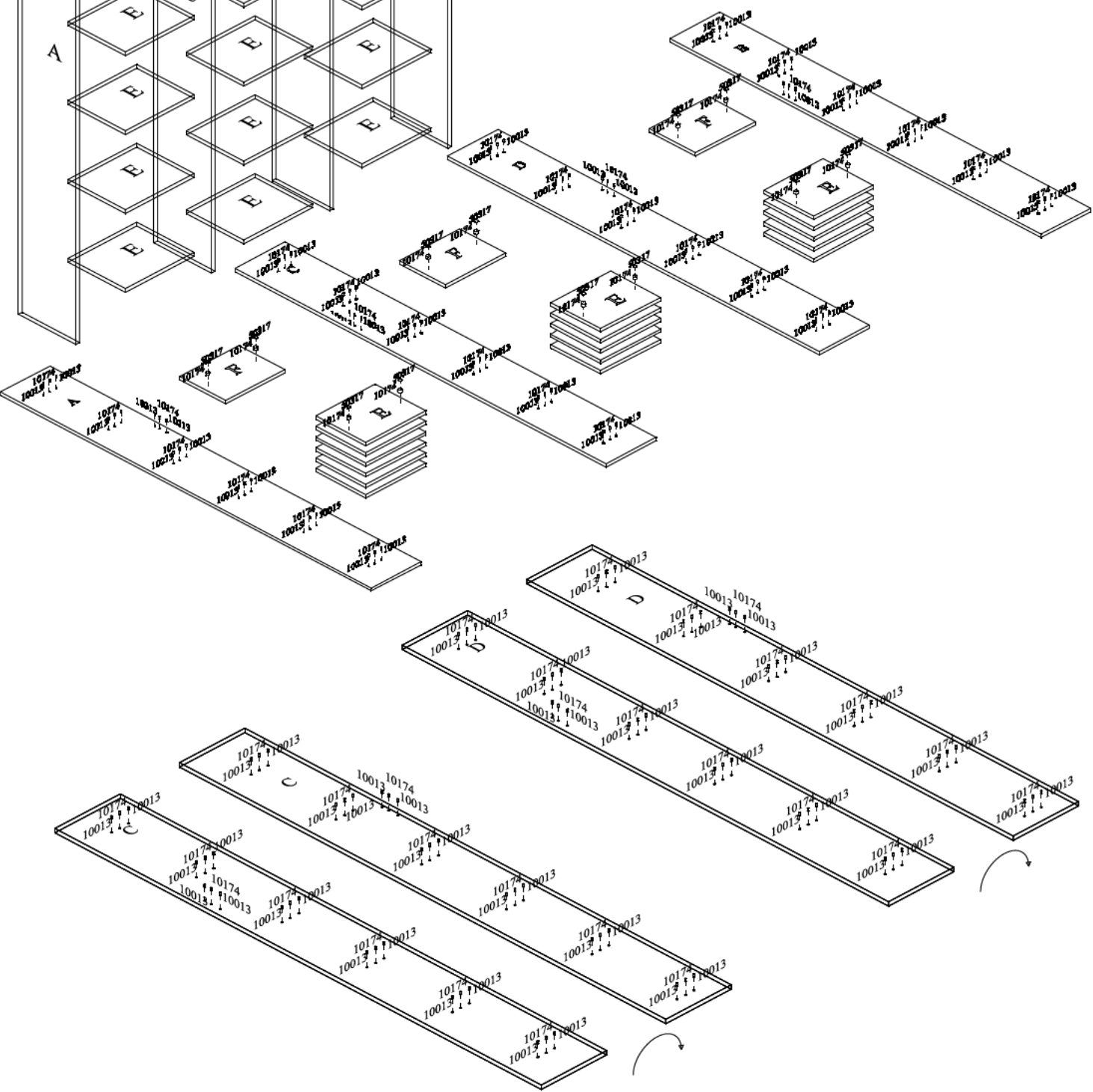
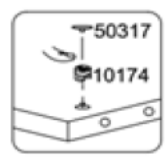
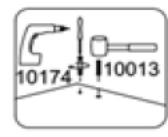
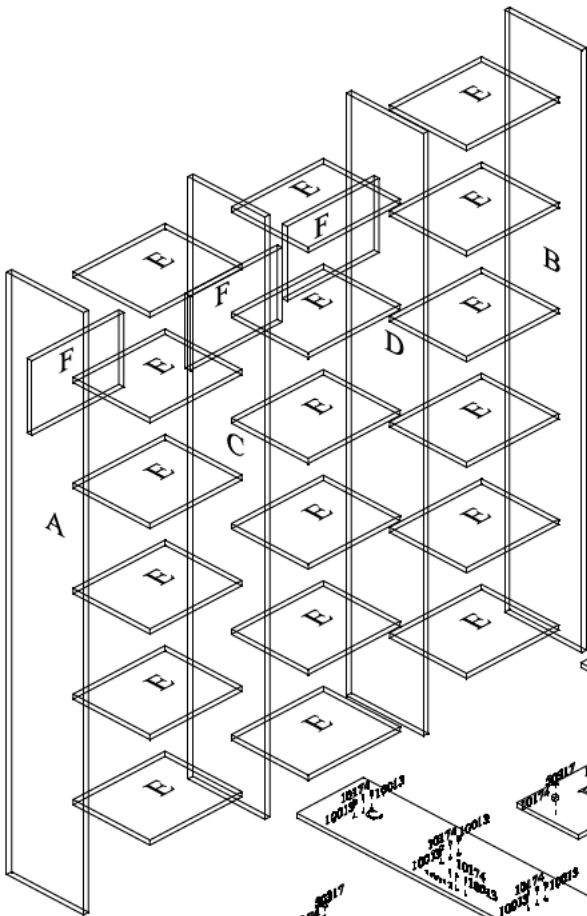

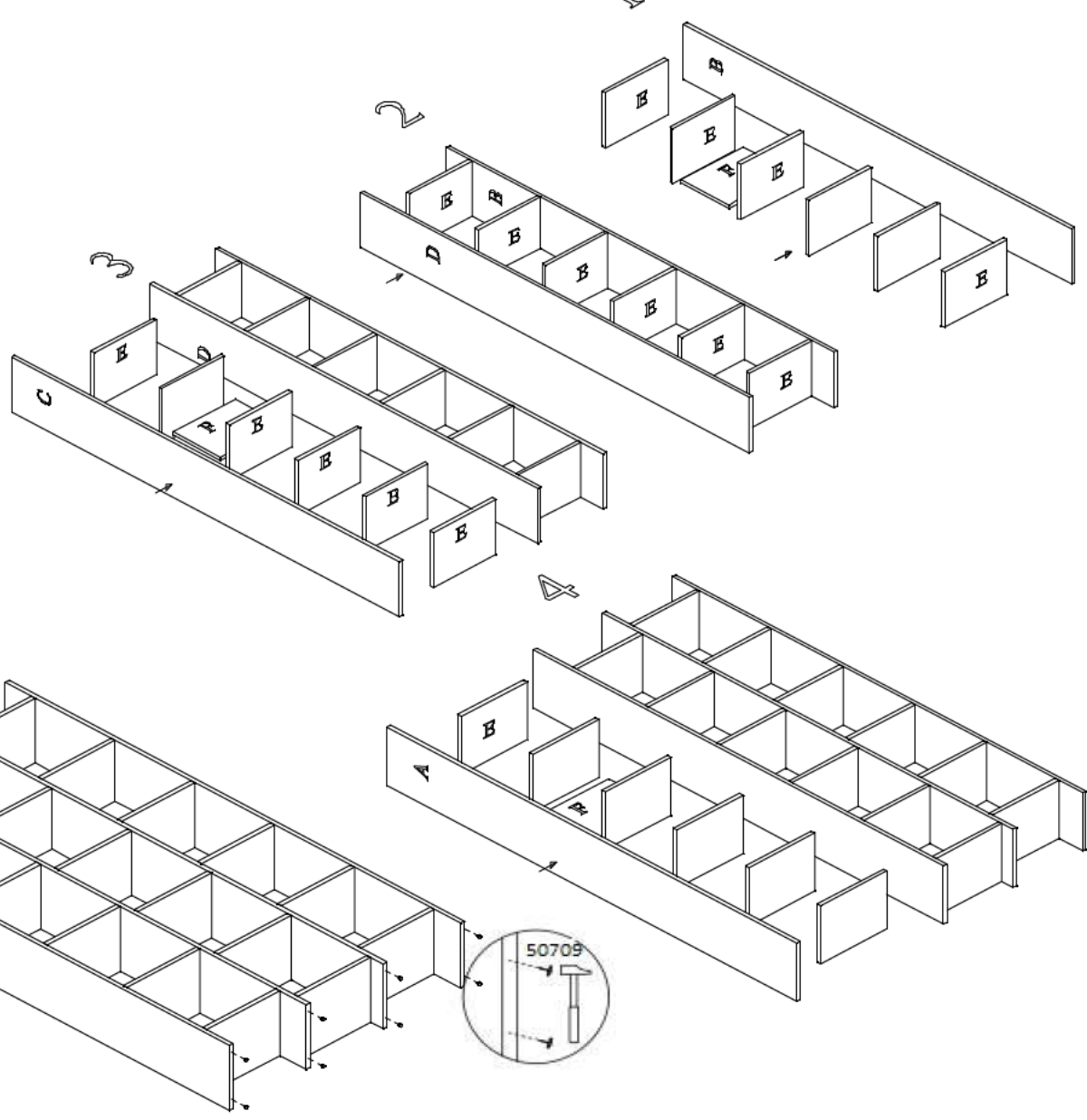
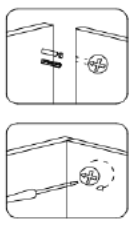

ΑΠΑΡΑΙΤΗΤΗ Η ΣΤΗΡΙΞΗ ΣΤΟΝ ΤΟΙΧΟ

