

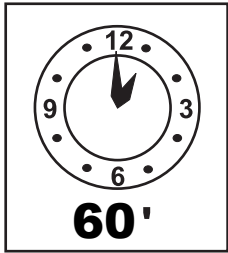

2

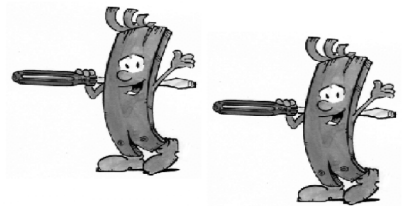

60'

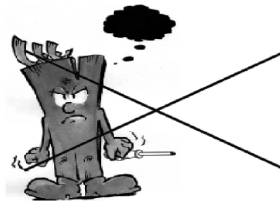
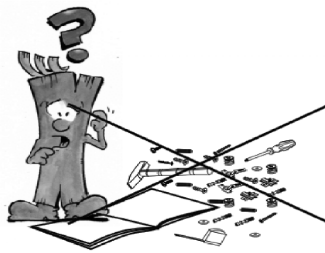
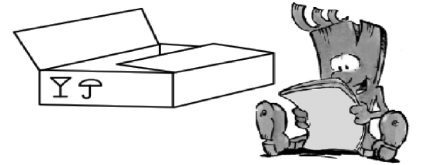
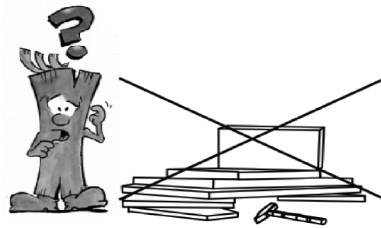
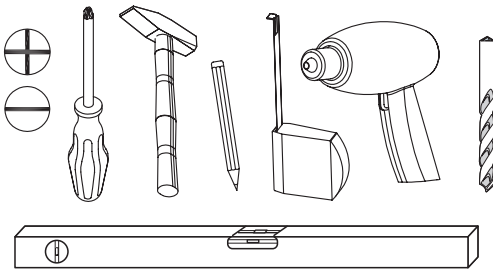

2 ΧΡΟΝΙΑ ΕΓΓΥΗΣΗ



A	2101x300	1/2
B	2101x300	1/2
C	568x300	2/2
D	568x300	2/2
E	4x 568x296	2/2
F	5x 385x296	2/2
G	568x80	2/2
H	2x 2009x294	1/2

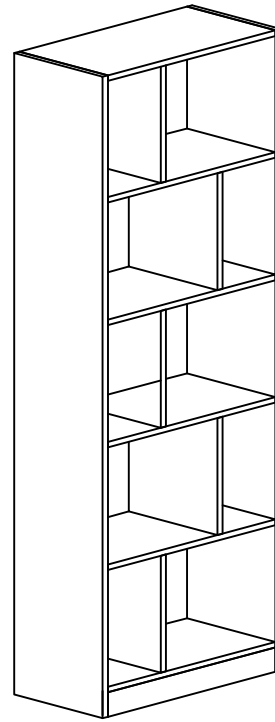

44x 10174	48x 8x30 10013	44x 50317	4x 50738	2x 51066	2x 10060	2x Φ 6/80 10021
4x Φ 3,5/16 10001	 10033					

1

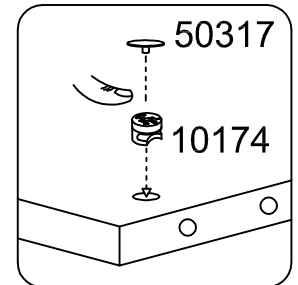
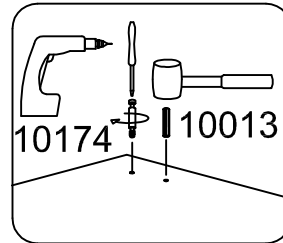
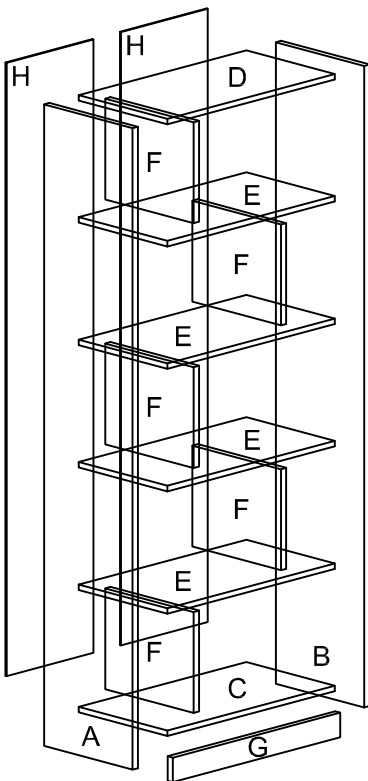

1.1

