

ASSEMBLY INSTRUCTION

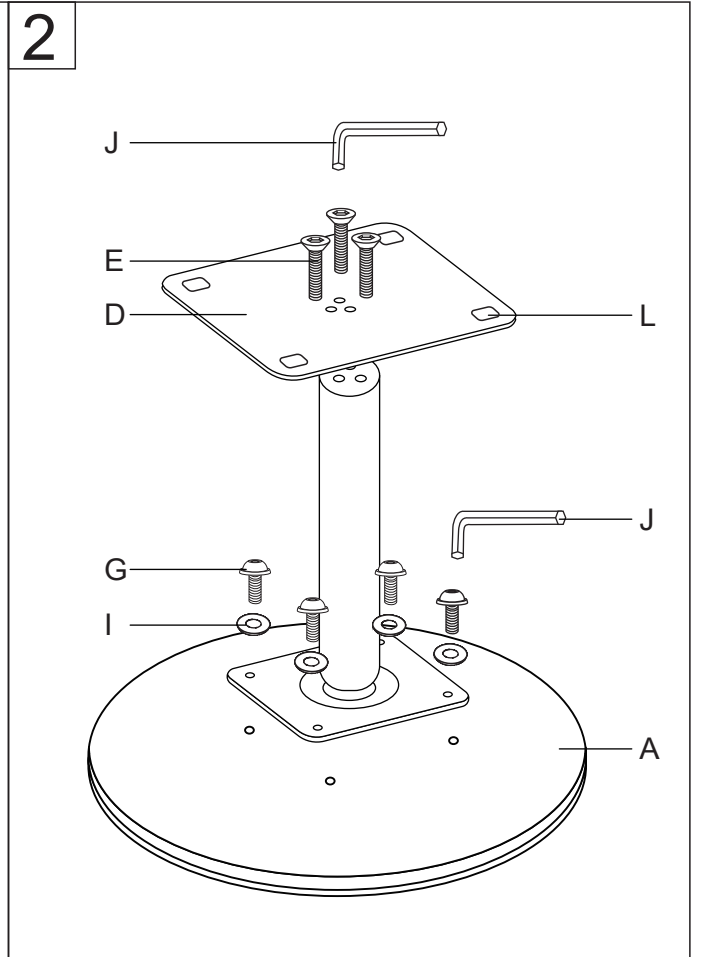
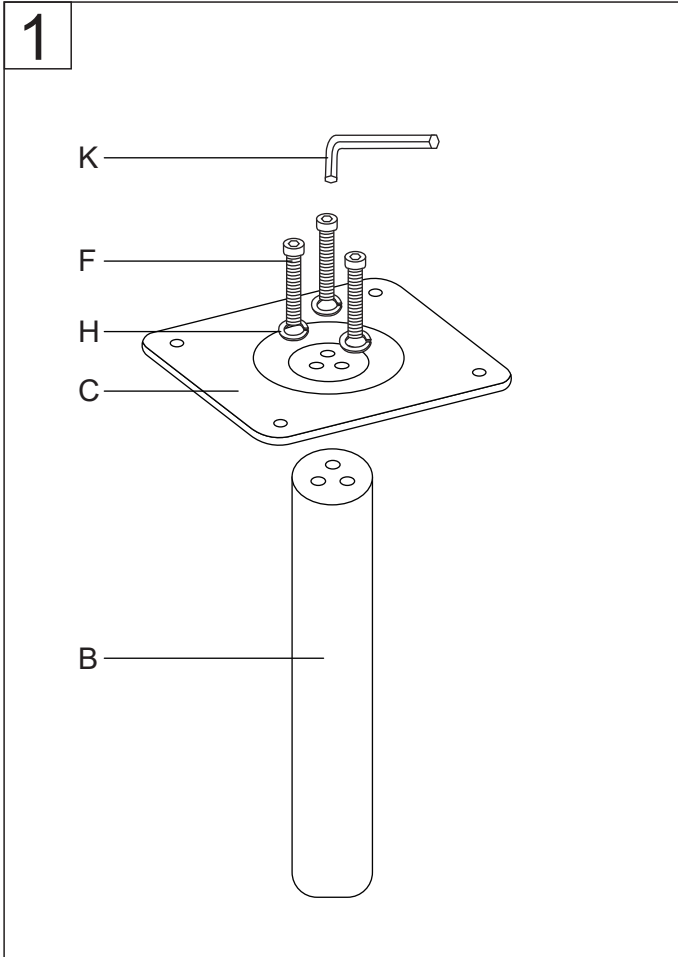

Ax1 	Bx1 	Cx1
Dx1 	Ex3 	Fx3
Gx4 	Hx3 	Ix4
Jx1 	Kx1 	Lx4