

GUIDE DE MONTAGE

1

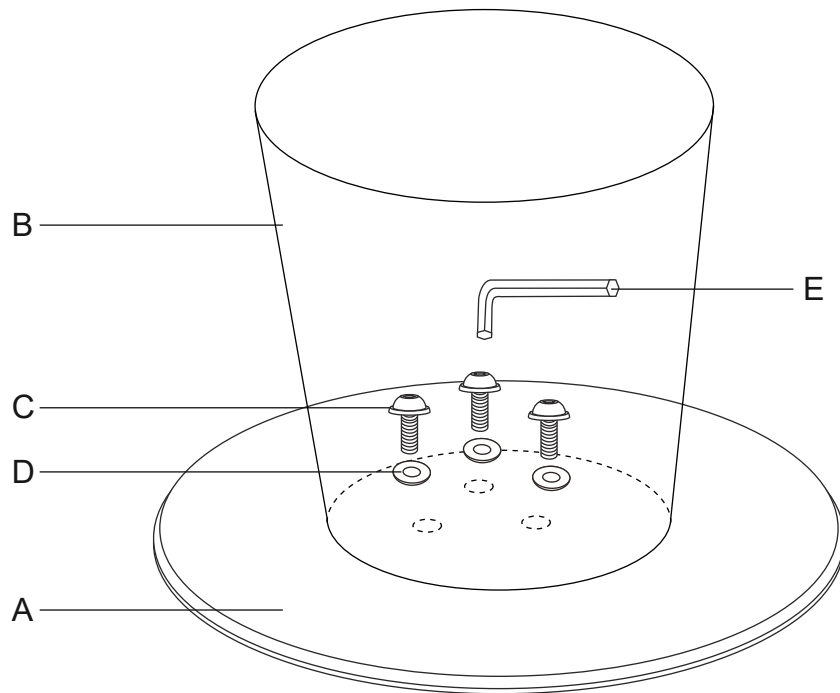

2

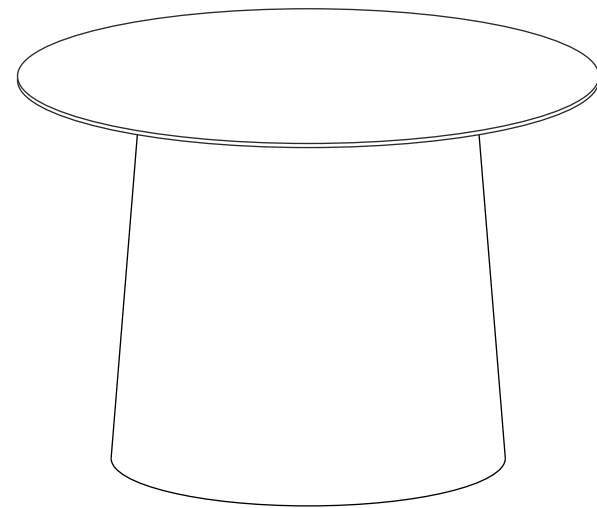

Ax1



Bx1

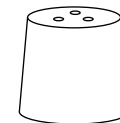

Cx3



Dx3



Ex1

